

PREMIUM FURNITURE

EN

DE





## Contents / Inhalt



MANAGER LINE NMO 2

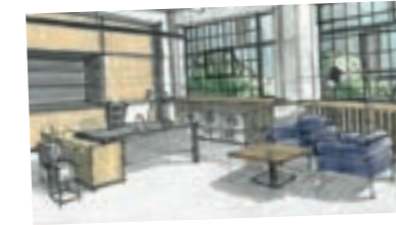

MANAGER LINE NMU 4



DESIGN LINE NQV 6



DESIGN LINE NQA 8



WOOD LINE NWU 10



WOOD LINE NWA 12



SMART LINE NVV 14



SMART LINE NVR 16



CLASSIC LINE NCV & NSV 18



CLASSIC LINE NCR & NSR 20



BENCH NQV 22



BENCH NQA 24



MEETING LINE NQP & NQB 26



SOLID LINE CAB 28



STANDARD LINE CDB 30



STANDARD LINE CLB & CLA 32



STANDARD LINE CWB & CTB 34



HOTCOM SF 36



ELECTRIC LINE ELM 38



ELECTRIC LINE ELK 40



STORAGE SYSTEMS 42



LOCKERS 50



ACOUSTIC BOOTHS 54

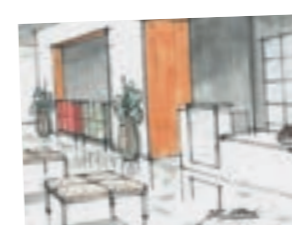

RECEPTIONS 60



TECHNICAL SECTION 66





# Manager line NMO

An executive desk with an elegant metal O-shape leg design. This concept of furniture is designed in the spirit of minimalist and functional design.

Managerschreibtisch mit elegantem Metallsockel in O-Form. Ein Konzept für Chefmöbel, das im Geiste des minimalistischen und funktionalen Designs entworfen wurde.





# Manager line NMU

A variation of the executive desk with high-quality U-shaped metal stands. Together with the base cabinet, this model creates an ideal impression for your office.

Eine Variante des Managerschreibtisches mit einem hochwertigen Metall-U-Fuß, der zusammen mit dem Unterschrank die ideale Kombination für Ihr repräsentatives Büro bildet.





# Design line NQV

The NQV desk is an astute design. The legs are formed of a square profile, connected graciously with no visible joints.

Ein Tisch mit klaren Linien, das ist der NQV-Tisch. Die Beine mit quadratischem Profil sind ohne sichtbare Verbindung zum Seitenteil verbunden.





# Design line NQA

The NQA office desk will meet all requirements down to the last detail.  
The modern desk legs are A-shaped with no visible joints.

Der NQA-Bürotisch erfüllt Ihre Anforderungen bis ins kleinste Detail.  
Die modernen A-förmigen Seiten des Schreibtisches haben keine sichtbare Verbindung.





# Wood line NWU

The NWU desk is a new modern series of desks with a wooden oak base. The NWU desk creates a seamless natural harmony.

Der NWU-Tisch ist eine neue moderne Tischreihe mit einem Untergestell aus Eichenholz. Der NWU-Tisch schafft ein Gefühl der angenehmen Verbindung mit der Natur.





# Wood line NWA

The design of the wooden oak base compliments the white desk top with a boardering oak strip. With this combination, you will create an ideal setup for your office with a natural element.

Das Design des Sockels aus Eichenholz harmoniert hervorragend mit der weißen Tischplatte, die mit Eichenband eingefasst ist. Mit dieser Kombination schaffen Sie das ideale Design für Ihr Büro mit einer natürlichen Atmosphäre.





# Smart line NVV

The NVV office desk is a universal modular desk that attracts attention not only with its appearance but also with its functionality and practicality.

Der NVV-Bürotisch ist ein vielseitiger Modultisch, der nicht nur durch sein Aussehen, sondern auch durch seine Funktionalität und Stabilität auffällt.





# Smart line NVR

The NVR desk is a multifunctional design, which will satisfy a wide range of requirements for professional offices. The legs of the desk have a circular cross-section.

Der NVR-Schreibtisch bietet eine breite Palette von Einsatzmöglichkeiten, um den Anforderungen eines jeden Verwaltungsbetriebs gerecht zu werden, egal ob es sich um ein großes Büro oder einen Konferenzraum handelt. Die Tischbeine haben einen runden Querschnitt.





# Classic line NCV & NSV

A typical feature of the NCV workbench is formed of two pillars, with a frame placed asymmetrically. The NSV models have the frame placed symmetrically.

Ein typisches Merkmal des NCV-Bürotisches sind die zweiseitigen Seitenwände, die quadratisch und asymmetrisch gestaltet sind. Bei NSV-Bürotisch sind die Profile symmetrisch platziert.





# Classic line NCR & NSR

This desk is designed to fit into any work environment. The desk uses an asymmetric NCR stand with a circular profile, while the NSR meeting table has a symmetrical stand.

Dieser Schreibtisch ist so konzipiert, dass er in jede Arbeitsumgebung passt. Der NCR-Arbeitstisch hat ein asymmetrisches Gestell mit rundem Profil I, der NSR-Besprechungstisch ein symmetrisches Gestell.





# Bench NQV

The Bench model desks are an ideal solution for open space workplaces. You can work smoothly along the entire assembly thanks to the snap-in inner leg. Bench desks can also be equipped with NVV and NVR legs.

Das Tischmodell Bench ist ideale Lösung für Open-Space-Büros. Es verfügt über eine entsprechend angepasste Konstruktion – der versetzte Innenfuß ermöglicht eine ungehinderte Bewegung am Tisch entlang. Die Tische können auch mit dem Gestell NVV und NVR geliefert werden.





# Bench NQA

The desk model Bench is another variant of the NQA series with an A-shaped leg. It is suitable for larger offices but can also be used for classic workplaces.

Das Tischmodell Bench ist eine weitere Variante der NQA-Reihe mit einem A-förmigen Gestell. Bench eignet sich für größere Büros, kann aber auch für klassische Arbeitsplätze verwendet werden.





# Meeting line NQP & NQB

High tables are ideal for a short business briefing, project presentation or lunch break. The tables are 110 cm high. The NQP table includes a presentation panel, while the NQB table is without a panel. The lower picture shows a variant of the desk with a NWB wooden base.

Stehische sind die ideale Wahl für eine schnelle Geschäftsbesprechung, eine Projektpräsentation oder eine Mittagspause. Die Tische sind 110 cm hoch. Der NQP-Tisch enthält ein Präsentationspaneel, der NQB-Tisch ist ohne Paneel. Das untere Bild zeigt die Variante des Tisches mit NWB-Holzgestell.





# Solid line CAB

The CAB workbench is made of laminated chipboard and offers an alternative to the common metal workbench design.

Der CAB-Arbeitstisch aus Melaminplatte ist für diejenigen gedacht, die diese Konstruktion der Metallkonstruktion vorziehen.





# Standard line CDB

The CDB model is an office desk made of laminated chipboard. Its sides are connected by a panel that also serves as a leg cover.

Der CDB-Schreibtisch ist ein Bürotisch aus Melaminplatte. Seine Seiten sind durch eine Platte miteinander verbunden, die auch als Beinraumblende dient.





# Standard line CLB & CLA

The desk frame is entirely made of metal, the legs are closed square profiles (30 × 30 mm). The design is simple and universal. The CLB table has a table top in 25 mm thickness and the CLA table in 19 mm.

Das Tischgestell ist ganz aus Metall, die Beine sind geschlossene Vierkantprofile 30 × 30 mm. Sein Design ist einfach und universell. Tisch CLB hat Tischplattenstärke 25 mm und Tisch CLA 19 mm.





# Standard line CWB & CTB

CWB desk with a laminate screen base is equipped with vertical and horizontal cable routing. The picture below shows a CTB desk with a metal cable channel.

Referenz Tisch CWB in technischer Ausführung mit Gestell, dessen Strukturelement eine Beinraumblende ist. Er ist mit einer vertikalen und horizontalen Kabelführung ausgestattet. Das untere Bild zeigt einen CTB-Tisch, bei dem das Strukturelement ein Metallkabelkanal ist.





# Hotcom SF

The Hotcom set is suitable for business meetings. The sides and top are made of 38 mm thick laminated chipboard. The picture below shows Hotcom wall-mounted with shelf.

Das Tischsystem Hotcom ist für geschäftliche Besprechungen geeignet. Seiten und obere Platte sind aus 38 mm starken laminierten Spanplatten gefertigt. Das untere Bild zeigt Hotcom für Wandmontage mit Ablagefach.





# Electric line ELM

The 3-segment ELM desk features 2 motors that are used to easily adjust your preferred height. All positions can be saved. The desk comes with a square profile legs. The round conference desk is model ELC.

Der ELM-Tisch ist ein höhenverstellbarer Dreisegmenttisch mit zwei Motoren. Sie können die Position schnell und bequem ändern und die von Ihnen gewählten Höhenpositionen speichern. Das Gestell des Tisches hat ein quadratisches Profil. Der runde Besprechungstisch ist Modell ELC.





# Electric line ELK

The aesthetic, three-segment, two-motor height-adjustable ELK desk fits perfectly into any modern office. It is possible to retrofit it with a memory function. The column leg of the desk has a rectangular profile. ELD is a conference table with a cross-shaped base..

Der ästhetische Dreisegmenttisch ELK höhenverstellbar mit zwei Motoren passt perfekt in jedes moderne Büro. Es besteht die Möglichkeit, ihn mit einer Memory-Funktion nachzurüsten. Das Gestell des Tisches hat ein rechteckiges Profil. ELD ist Konferenztisch mit einem kreuzförmigen Fußgestell.





## Cabinets

Cabinets SN and KN feature overlay doors. Cabinets SN have 19 mm thick shelves. Cabinets KN have 25 mm thick shelves and 25 mm thick top cabinet panel. SD cabinets have cover plates and fixed shelves without drilling.

## Schränke

Die SN- und KN-Schränke sind mit aufliegenden Türen. Die SN-Schränke haben die Einlegeböden der Stärke 19 mm, die KN-Schränke haben die Einlegeböden der Stärke 25 mm und herüberziehende Oberplatte über die Türkante der Stärke 25 mm. SD-Schränke haben Abdeckplatten und feste Einlegeböden ohne Bohrungen.

## Double door cabinets

Cabinets with hinged doors enable clear and simple storage of files, office equipment and personal belongings. Glass door option allows a quick overview of the stored documents.

## Drehtürschränke

Die Schränke ermöglichen eine übersichtliche und einfache Aufbewahrung von Akten, Büroausstattung und persönlichen Gegenständen. Darüber hinaus ermöglichen Schränke mit Glastüren einen schnellen Überblick über Ihre Dokumente.



## Sliding door cabinets

Cabinets with sliding doors save space and allow easy access to office documents.

## Schiebetürenschränke

Schränke mit Schiebetüren sind platzsparend und ermöglichen einen einfachen Zugriff auf Bürourunterlagen.

## Tambour cabinets

Tambour cabinets offer a rolling door opening that can help save space in small office rooms. When the tambour cabinet is opened, the rolling blind is hidden inside the cabinet.

## Rollladenschränke

Schränke mit Rollläden ermöglichen einen schnellen und unkomplizierten Zugriff auf Dokumente und bieten gleichzeitig maximalen Stauraum. Wenn der Schrank geöffnet wird, ist das Rollo vollständig im Schrank verborgen.



## Open bookcases

Open cabinets are a perfect feature of any office and an ideal solution for archives and libraries.

## Offene Regale

Offene Regale sind ideal für jedes Büro, da sie einen schnellen Zugriff auf die gelagerten Materialien ermöglichen und die perfekte Lösung für Archive und Bibliotheken sind.



## File cabinets

File cabinets are an excellent solution when it comes to storing a large number of documents in a clear and well-sorted manner.

## Hängeregistraturschränke

Hängeregistraturschränke sind die perfekte Lösung, wenn es darum geht, eine große Anzahl von hängenden Dokumenten übersichtlich und gut sortiert aufzubewahren.



## Plinths / Sockel



(3) Metal 40 mm  
KN/SN



(2) Melamine 40 mm  
KN/SN/SD



(7) Metal 20 mm  
KN/SN



(9) Rectification 1-10 mm  
KN/SN



(K) Metal 70 mm  
KN



(4) Melamine 70 mm  
KN/SN



(8) Metal 70 mm  
KN/SN



(I) Rectification 17 mm  
KN/SN



## Juxtaposed cabinets

All documents are easily accessible thanks to the ingeniously designed storage space that also increases the work surface.

## Anstellschränke

Sämtliche Unterlagen sind griffbereit dank des genial gelösten Stauraums, der Ihre Arbeitsfläche vergrößert.

## Combined cabinets

Combined cabinets enable a large variability of cabinet modules in configurations to meet customer requirements. Individual parts of the cabinet, such as doors, niches, glass and drawers can be chosen to create a unique solution for your office.

## Kombischränke

Kombischränke ermöglichen eine große Variabilität der Schrankmodule je nach Kundenwunsch. Bei der Gestaltung der einzelnen Schrankteile wie Türen, Nischen, Glas und Schubladen können Sie aus einer Vielzahl von Möglichkeiten wählen.



## Desk with built-in drawer unit

The appearance and design of the drawers are compatible with the office desks we produce. Various patterns and colour types will complement any work desk.

## Container

Die Bürocontainer sind in Aussehen und Design auf unsere Bürotische angepasst. Dank der Möglichkeit, das Design oder die Abmessungen zu konfigurieren, können Sie jeden Schreibtisch ergänzen.

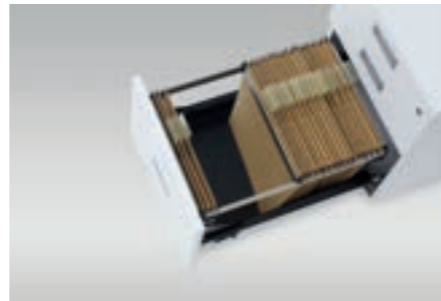
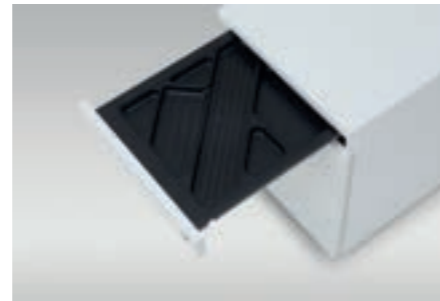

## Desk extension drawers

Desk extension drawers are placed on a low plinth or on adjustable gliders. The height is adapted to the height of the desk.

## Anstellcontainer

Die Anstellcontainer können in Versionen auf Gleitern oder auf Sockel sein. Die Höhe des Anstellcontainers ist an die Höhe des Schreibtisches angepasst.

## Mobile and multimedia drawers

Mobile drawer units fit perfectly into an open space office. The universal storage space can be used in countless ways. The multimedia drawers create an ideal place for printers, servers, computers and other equipment.

## Mobile und Multimedia-Container

Ein mobiler Container ist überall dort, wo er gebraucht wird. Er eignet sich besonders für Open Space Büros, wo die universalen Stauräume vielfältig benutzt werden können. Der Multimedia-Container wurde speziell zum Aufbewahren von Druckern, Servern, Computern, Datenspeichern und anderen technischen Geräten entworfen.



## Tower cabinets

Tower pull-out cabinets represent a stylish solution for storage space. The cabinets provide a large amount of storage options and are used to elegantly separate individual workspace.

## Tower-Schränke

Tower-Schränke sind eine elegante Aufbewahrungslösung. Der Tower-Schrank bietet viele Ablagemöglichkeiten und dient zur Trennung einzelner Arbeitsplätze.

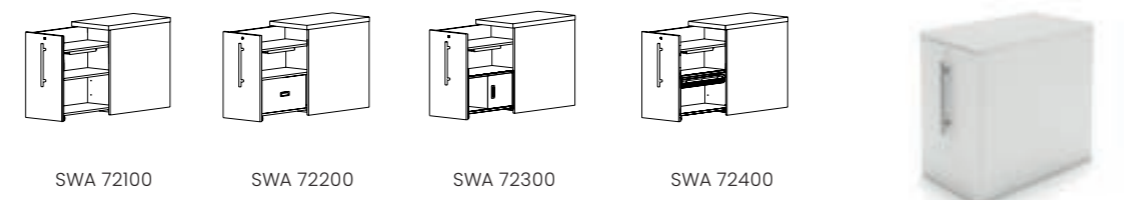
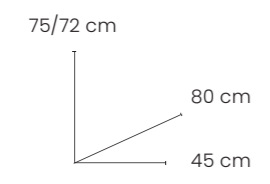

Version / Ausführung / Provedení / "L"

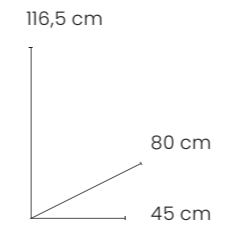

Version / Ausführung / Provedení / "L"



## Locker cabinets

Modern and functional storage system for offices as well as private interiors. We offer lockers on LTD plinths with a height of 4 cm, metal legs with a height of 10 cm or 27 cm.

## Locker Schränke

Moderner, intelligenter und funktioneller Stauraum für Büros, Verwaltungsgebäude und private Innenräume. Wir bieten Locker Schränke auf Melaminsockel mit einer Höhe von 4 cm, Metallfüßen mit einer Höhe von 10 cm oder 27 cm an.



## Design / Ausführung

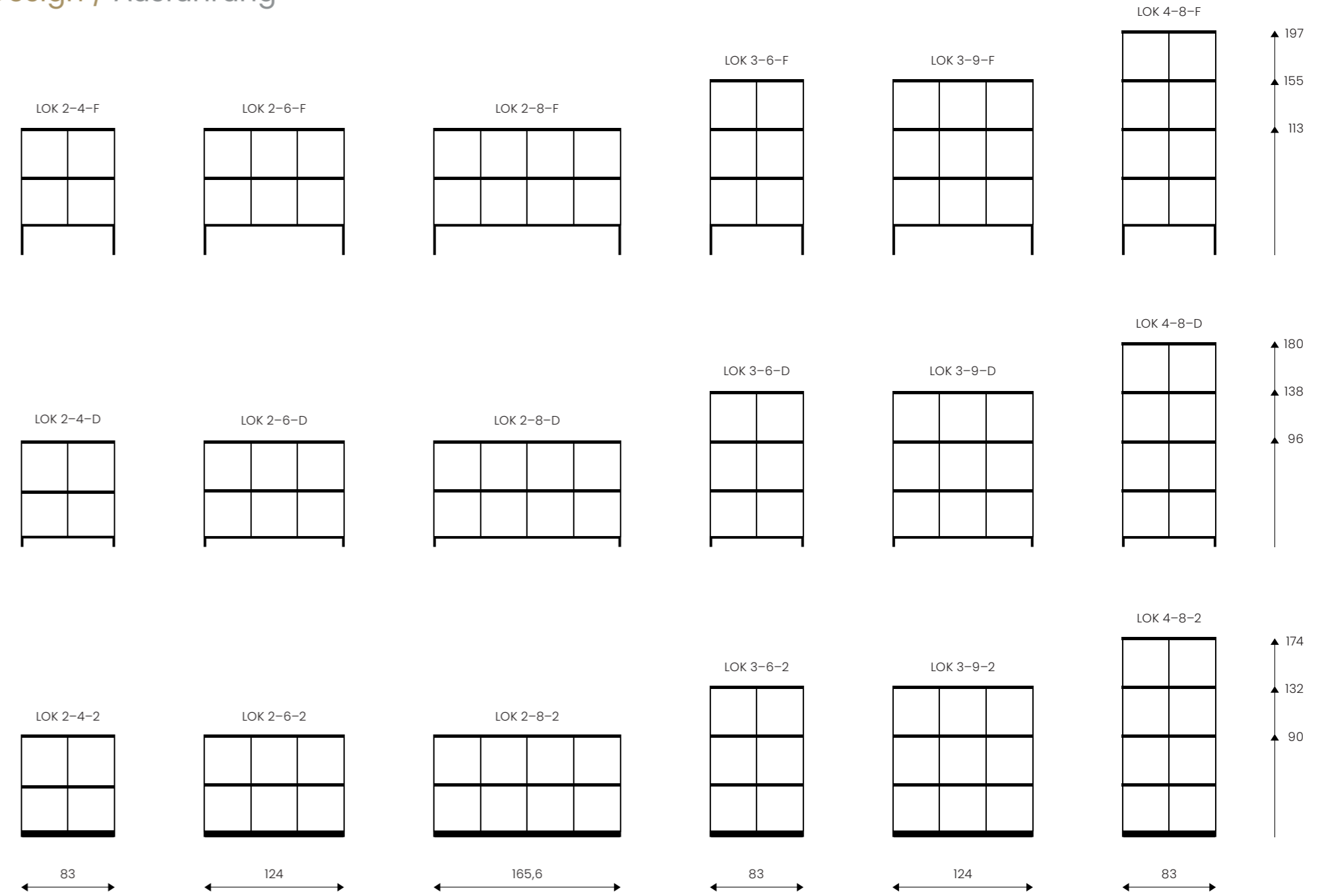



Locker cabinets are a versatile solution for safe and organized storage of personal and office belongings. The basic design is supplied with a tip-on opening mechanism, and there is a choice between mechanical and electronic locks. The cabinets are available in anthracite and white finishes, with other surfaces offered in UNI colours.

Locker Schränke sind eine vielseitige Lösung zur sicheren und übersichtlichen Aufbewahrung von persönlichen und beruflichen Gegenständen. Die Grundausführung verfügt über eine Tip-on-Öffnung, es stehen mechanische und elektronische Schlösser zur Auswahl. Das Angebot umfasst Korpusse in Anthrazit und Weiß, weitere Oberflächen in UNI-Farben.



Indian Curry



Mineral Grey



Baked Brick



Sandy Lilac



Graphite Blue



Industrial Green



White

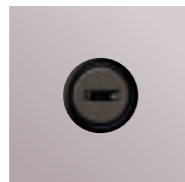

(J) Lehmann mechanical lock



(Z) Lehmann dial lock



(B) Burg Intro.Code



(E) Burg Intro.RFID



(C, F) Burg W-TWP-01



(R) Lehmann M410.RFID

(J) Mechanical lock, (Z) Mechanical code bolt lock, (B) Electronic code lock, (E) Electronic RFID lock, (C) Electronic code lock, (F) Electronic code lock with RFID card, (R) Hidden electronic RFID lock with visual signalling.

(J) Mechanisches Schloss, (Z) Mechanisches Codeschloss, (B) Elektronisches Codeschloss, (E) Elektronisches RFID-Schloss, (C) Elektronisches Codeschloss, (F) Elektronisches Codeschloss mit RFID-Karte, (R) Verdecktes elektronisches RFID-Schloss mit optischer Signalisierung.

(J) Mechanický zámek, (Z) Mechanický kódový zámek závorový, (B) Kódový elektronický zámek, (E) Elektronický RFID zámek, (C) Kódový elektronický zámek, (F) Kódový elektronický zámek s RFID kartou, (R) Skrytý elektronický RFID zámek s optickou signalizací.





## Acoustic booths

The free-standing acoustic booth is a modern element that creates a quiet zone in a noisy office environment. It is made of AL anodized profiles and a first-class acoustic Recytex fillings. The ceiling is equipped with an automatic LED lighting and ventilation.

## Akustikboxen

Die freistehende Akustikbox ist ein modernes Designelement, das in einer lauten Büroumgebung eine Ruhezone schafft. Es besteht aus eloxierten AL-Profilen, die Füllungen bestehen aus dem erstklassigen Akustikmaterial Recytex. Die Decke der Boxen ist mit automatischer LED-Beleuchtung und Belüftung ausgestattet.

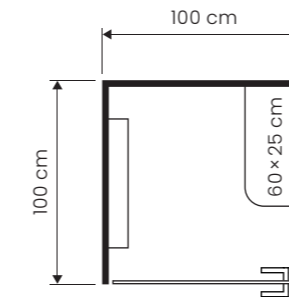

ASB 11



## Acoustic booth 1

This 1-person booth is well designed for business and personal calls. The booth is equipped with a side desk and a comfortable backrest. It can be supplemented with a bar chair for even greater comfort.

## Akustikbox 1

Diese Box ist für 1 Person gedacht, Sie werden sie für Ihre beruflichen und privaten Gespräche zu schätzen wissen. Die Box ist mit einem Beistelltisch und einer bequemen Rückenlehne ausgestattet, für noch mehr Komfort kann sie mit einem Barstuhl ergänzt werden.



## Acoustic booth 1+

This booth is an ideal working space for one person, where you will have privacy and peace for your work. Available in two versions, with upholstered bench and desk or with high chair and raised table.

## Akustikbox 1+

Diese Box stellt eine ideale Arbeitsumgebung für eine Person dar, in der Sie Privatsphäre und Ruhe für Ihre Arbeit haben. Wir bieten zwei Versionen an, mit gepolsterter Bank und Arbeitstisch oder mit Hochstuhl und erhöhtem Tisch.

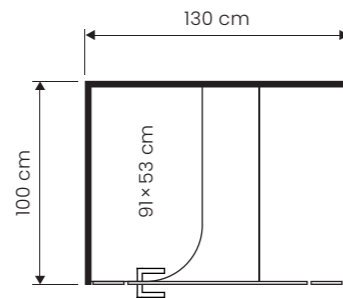

ASB 12

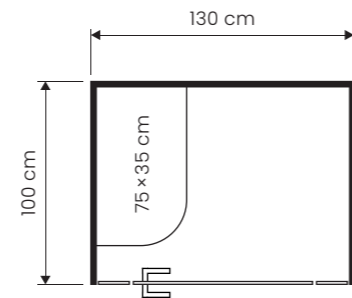

ASB 13

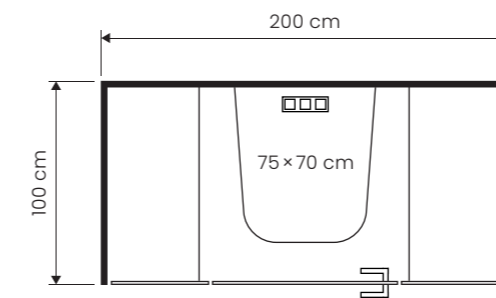

ASB 21



## Acoustic booth 2

This booth is designed for 2 people and is equipped with two fans with the possibility of power regulation. The main image features upholstered backrests. The outer sides are from LTD.

The bottom picture has glass back panels, and the external sides of the box are upholstered.

## Akustikbox 2

Diese Box ist für 2 Personen ausgelegt, sie ist mit zwei Ventilatoren mit der Möglichkeit der Leistungsregulierung ausgestattet.

Das Hauptbild hat eine stoffbespannte Rückseite, die Außenseiten sind aus LTD-Melaminplatten.

Das untere Bild hat eine Glasrückseite, die Außenseiten der Box sind stoffbespannt.



## Acoustic booth 4

Booth 4 is designed for four people. With this booth, you can choose between a variant with an upholstered bench and desk or the variant with a Hotcom table and bar stools (lower picture). The booth is equipped with four fans and two LED stripes.

## Akustikbox 4

Box 4 ist für 4 Personen ausgelegt. Bei dieser Box besteht die Möglichkeit, zwischen einer Variante mit gepolsterter Bank und Tisch oder der Variante im unteren Bild mit Hotcom-Tisch und Barstühlen zu wählen. Die Box ist mit vier Lüftern und zwei LED-Streifen ausgestattet.

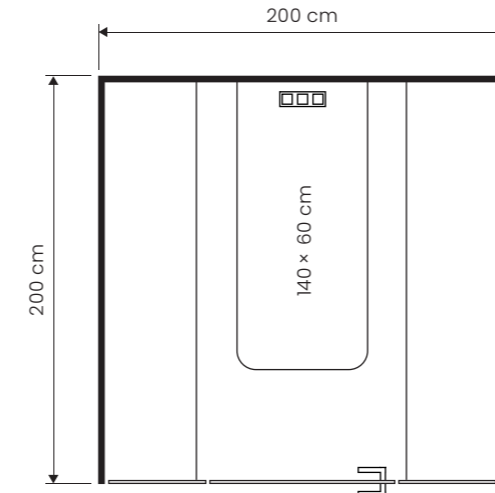

ASB 41  
ASB 42



Bello



Sitty



Winx

Bar stools for booth 1, booth 1+ and booth 4  
Barstühle für Box 1, Box 1+ und Box 4  
Barové židle pro Box 1, Box 1+ a Box 4



## Acoustic Booths

Thanks to a wide selection of fabrics, you can easily match AS booths with the interior of your office. All booths are equipped with a 220 V electrical outlet, RJ45 and USB ports. Our booths guarantee a pleasant acoustic environment. All booths were tested by an accredited acoustic testing laboratory.

## Akustikboxen

Dank der großen Stoffauswahl können Sie die AS-Boxen problemlos an die Inneneinrichtung Ihres Büros anpassen. Alle Boxen sind mit einer 220-V-Steckdose, RJ45 und USB ausgestattet. Unsere Boxen garantieren ein angenehmes akustisches Umfeld, basierend auf technischen Tests, die von einem akkreditierten Prüflabor durchgeführt wurden.



## Receptions Office

OFFICE reception desks have a simple and elegant design. The front panel illumination with LED strip underlines their attractiveness. The centre panel is L-shaped or L-shaped with a fine line corresponding to the design of the trendy lockers.

## Theken Office

Die Empfangstheken zeichnen sich durch ein schlichtes und elegantes Design aus. Die LED-Streifenbeleuchtung der Frontblenden unterstreicht ihre Attraktivität. Das Mittelpaneel ist L-förmig oder L-förmig mit einer feinen Linie, die dem Design der trendigen Locker entspricht.



## Design / Ausführung / Provedení / RCO

### RCO 30

design with lower worktop

Ausführung mit geneigter Arbeitsfläche

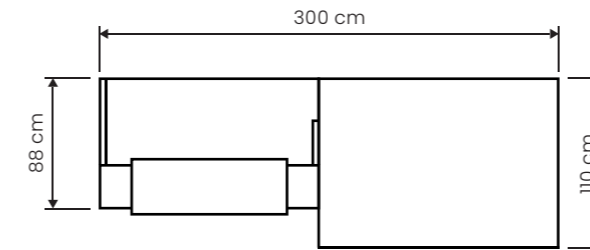

### RCO 25

rectangular reception desk

rechteckige Rezeption

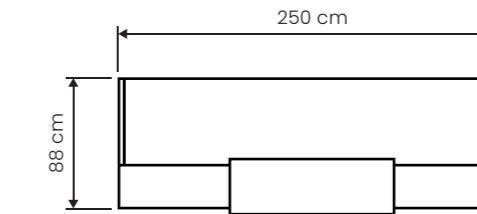

### RCO 15

rectangular reception desk

rechteckige Rezeption

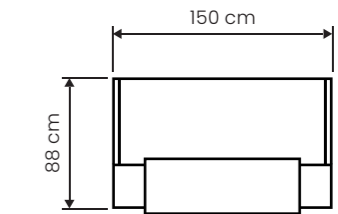

## Model / Modell

1

L-shaped panel – panel width 100 cm, 1,9 cm thick  
 Paneel L-förmig – Paneelbreite 100 cm, 1,9 cm dick



2

L-shaped panel, design locker – panel width 100 cm, 1,2 cm thick  
 Paneel L-förmig, Design Locker – Paneelbreite 100 cm, 1,2 cm dick

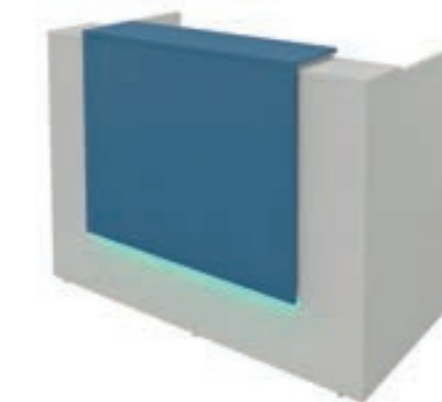

The reception height without panel is 110 cm. The reception is equipped with a working desk.  
 Thekenhöhe ohne Paneel ist 110 cm. Die Empfangstheke ist mit Arbeitstisch ausgestattet.



## Receptions Variant

The reception area is the gateway to your company and the impression it gives can be essential. With our wide range of designs, colours and finishes you can create a unique reception counter that represents you perfectly. LED strips can be inserted between the MFC or glass front panels.

## Theken Variant

Der Empfangsbereich ist das Tor zu Ihrem Unternehmen und der Eindruck, den er vermittelt, kann entscheidend sein. Mit unserer breiten Palette an Designs, Farben und Ausführungen können Sie eine unverwechselbare Empfangstheke schaffen, die Sie perfekt repräsentiert. Zwischen die Frontblenden aus Melaminplatten oder Glas können LED-Streifen eingefügt werden.



## Design / Ausführung



RCR Z

reception walls made of glazed MFC boards  
Wände der Theke aus glatten Melaminplatten

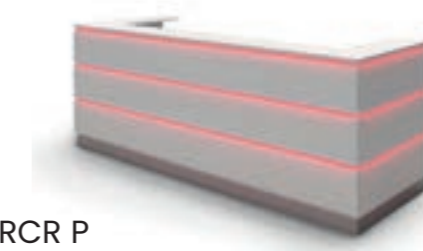

RCR P

reception walls with three stripes from MFC boards  
Wände der Theke mit 3 Frontblenden aus Melaminplatten

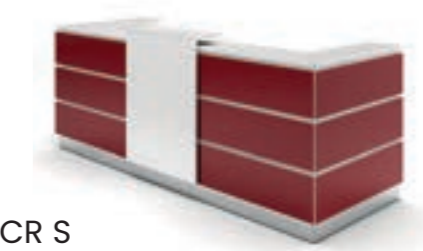

RCR S

reception walls with three stripes from painted glass  
Wände der Theke mit 3 Frontblenden aus lackiertem Glas

## Form / Form / Tvar

U16	U20	U24	U28	U32	U36	U40
width / Breite						
169 cm	209 cm	249 cm	289 cm	329 cm	369 cm	409 cm

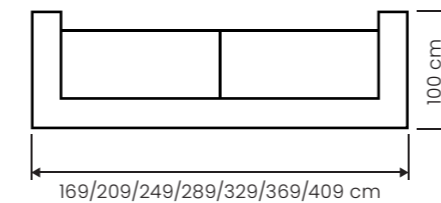

T16	T20
width / Breite	
160 cm	200 cm

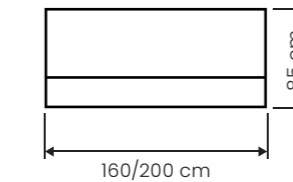

L66, R66	L26, R26	L11, R11	L09, R09
dimension / Maß			
165 × 165 cm	205 × 165 cm	165 × 100 cm	205 × 100 cm

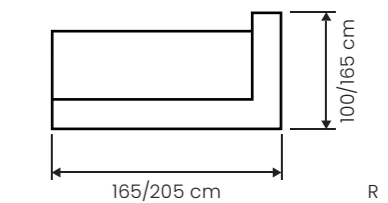

## Model / Modell / Model



1 without panel  
ohne Paneel



2 bag shelf 80 cm  
Taschenablage 80 cm



3 panel 80 × 42 cm  
Paneel 80 × 42 cm



4 panel 80 × 73 cm  
Paneel 80 × 73 cm



5 panel 80 × 105 cm  
Paneel 80 × 105 cm





We can create a perfect work environment for you – our services cover everything from the design stage to the actual implementation. Colours of your choice will characterise your company, improve work performance and create a pleasant atmosphere in your office.

Wir schaffen die perfekte Arbeitsumgebung für Sie vom Entwurf bis zur Realisierung. Richtig gewählte Farben repräsentieren Ihr Unternehmen, steigern die Arbeitsleistung und schaffen eine angenehme Atmosphäre.



NGV



Technical section  
Desks construction

Technischer Teil  
Tischkonstruktionen

Manager line

■ Profil 80 × 30 mm

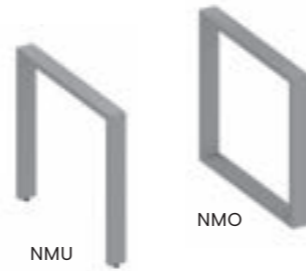

Design line

■ Profil 50 × 50 mm

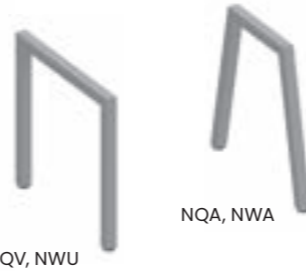

Wood line

■ Profil 50 × 45/60 mm

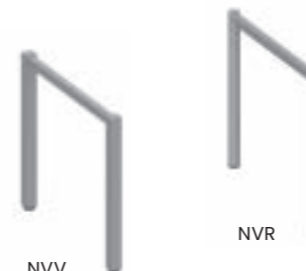

Smart line

■ Profil 50 × 50 mm

● Profil Ø 50 mm

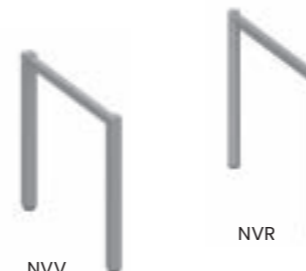

Bench line

■ Profil 50 × 50 mm

● Profil Ø 50 mm



Classic line

■ Profil 50 × 50 mm

● Profil Ø 50 mm



Standard line

■ Profil 30 × 30 mm

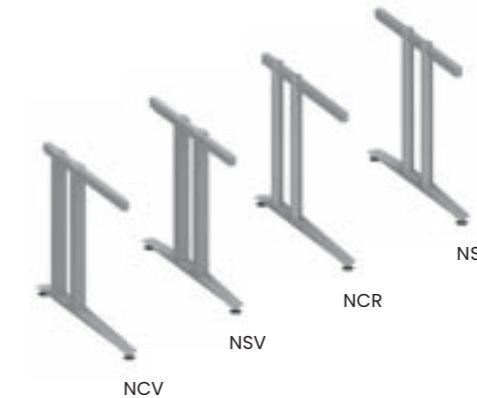
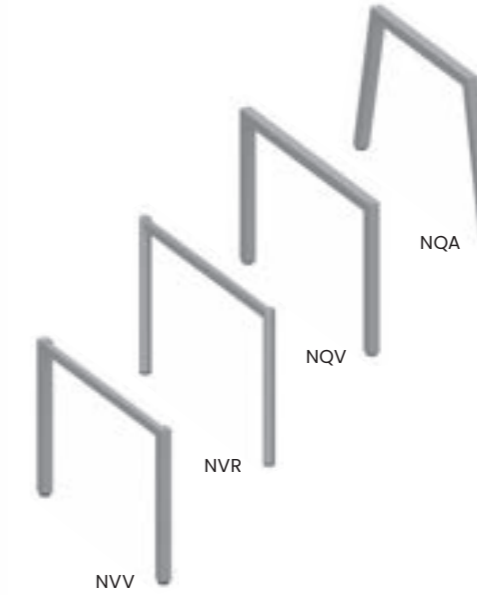

Adjustable height  
Verstellbare Höhe



Adjustable height - plastic  
Verstellbare Höhe - Kunststoff

Fixed height  
Feste Höhe

Wood line



■ Profil 50 × 45/60 mm



### Standard line CWB

■ Profil 30 × 30 mm



### Standard line CTB

■ Profil 30 × 30 mm



### Electric line ELM

■ Profil 70 × 70 mm



### Electric line ELK

■ Profil 80 × 50 mm



Laminated modesty panel  
Melaminbeinraumbende



ER 08-20 (80-200 cm)  
Wall-mounted shelf  
Wandregal



ER 28-40 (80-200 cm)  
Wall-mounted shelf  
Wandregal



EN 58-62 (80-120 cm)  
Table extension  
Tischaufbau



Metal modesty panel  
Lochblechbeinraumbende



EV 56-59 (180 × 60-200 × 80 cm)  
Hanger wall  
Kleiderwand



EV 60-63 (180 × 60-200 × 80 cm)  
Hanger wall with mirror  
Kleiderwand mit Spiegel



EN 64-70 (140-200 cm)  
Table extension  
Tischaufbau



Plexiglass modesty panel  
Plexiglasbeinraumbende



EN 94-99 (45 °-60 °-90 °)  
Table extension  
Tischaufbau

Accessories  
Zubehör  
Doplňky



# Accessories Zubehör



**B01**  
Box with drawer under the desk – laminated  
Box mit Schublade unter der Tischplatte – Melamin

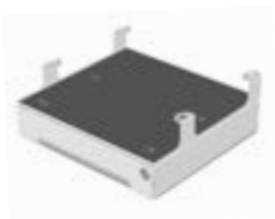

**B03**  
Box with drawer under the desk – metal  
Box mit Schublade unter der Tischplatte – Metall



**B02**  
Box with drawer under the desk – metal  
Box mit Schublade unter der Tischplatte – Metall



**CP2**  
Printer holder (for Smart Line, Classic Line)  
Drucker-Halter (für Smart Line, Classic Line)



**CP3**  
Pull out holder (for Smart Line, Classic Line)  
Ausziehbarer Halter (für Smart Line, Classic Line)



**CP5**  
PC holder  
PC-Halter



**DO50**  
PC holder  
PC-Halter



**DO51**  
PC holder  
PC-Halter



Cable tray (for Standard Line CDB, CWB)  
Kabelkanal (für Standard Line CDB, CWB)



Cable tray tiltable  
Kabelkanal kippbar

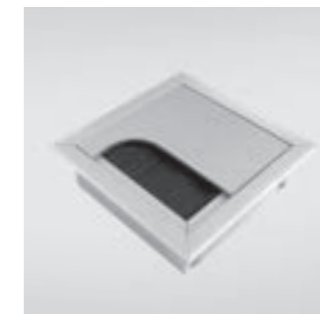

**DO 80-81**  
Grommet – aluminium  
Kabelausslass – Aluminium



**DO 87-89**  
Grommet  
Kabelausslass



Cable tray (for Standard Line CLB, CLA)  
Kabelkanal (für Standard Line CLB, CLA)



**SK1**  
Cable clip  
Kabelklemmer



**DO 99**  
Grommet to the edge of the table  
Kabelausslass in der Kante des Tisches



**VD1**  
Sliding table top  
Schiebeplatte



**O-114**  
Vertical cable drop – fabric  
Stoffkabelkette



**O-104**  
Vertical cable drop – plastic  
Kunststoffkabelführung



**DO 96-98**  
Grommet  
Kabelausslass



**VLI**  
Cable flap  
Klappleiste



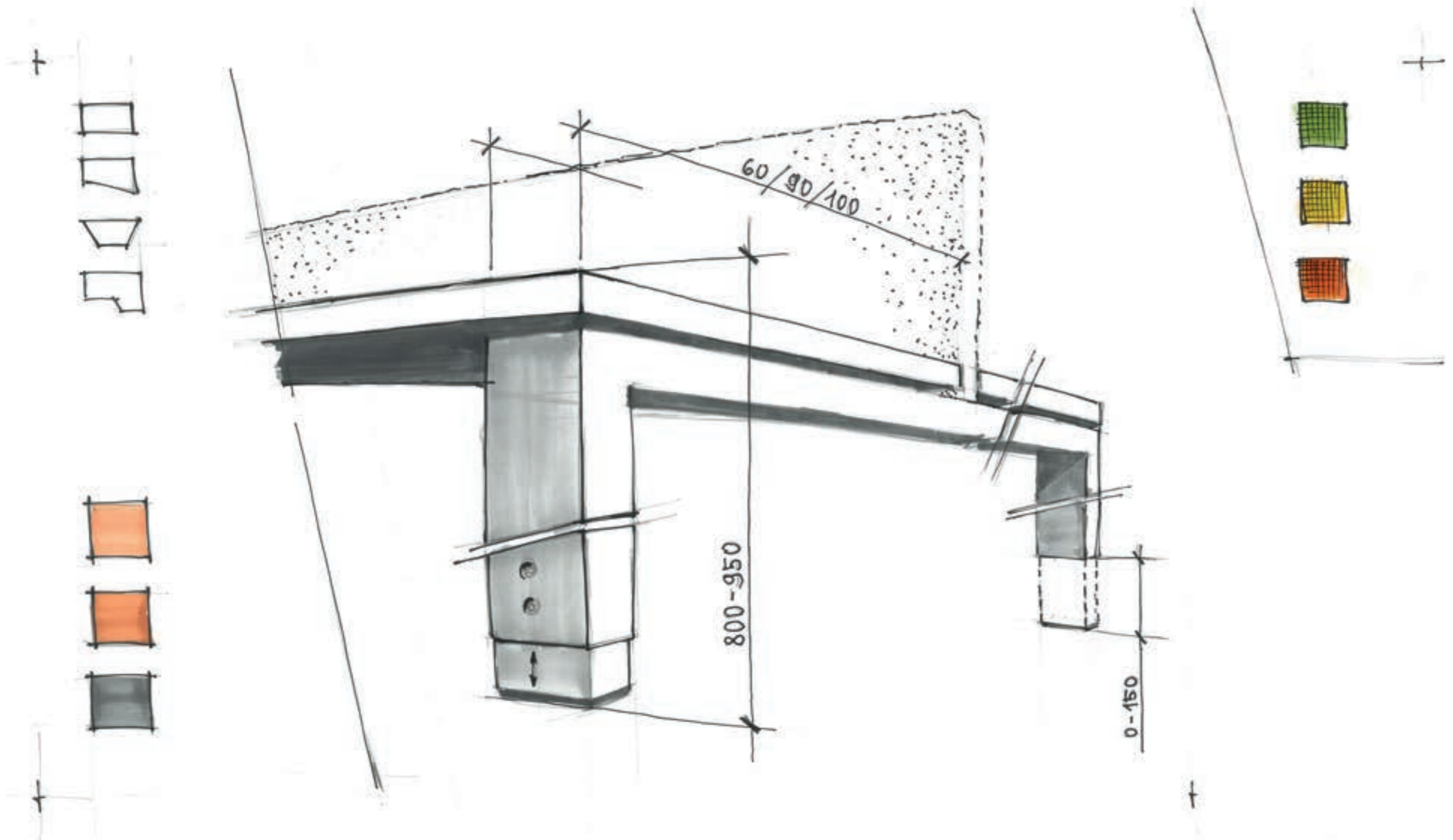

## Products overview Produktübersicht

Desks / Tische / Stoly.....	74
Electric desks / Elektrotische / Elektrické stoly.....	82
Cabinets KN / Schränke KN / Skříně KN .....	84
Cabinets SN / Schränke SN / Skříně SN .....	88
Cabinets SD / Schränke SD / Skříně SD .....	91
Drawer units / Container / Kontejnery .....	92
Screens / Trennwände / Paravány .....	94
Acoustic elements / Akustikelemente / Akustické prvky .....	95



# Desks / Tische / Stoly

**Design line** NQV, NQA   **Smart line** NVV, NVR   **Classic line** NCV, NSV, NCR, NSR   **Standard line** CWB, CTB, CDB, CLB, CLA

## Desks / Tische / Stoly

(cm)	model	(cm)	model	(cm)	model	(cm)	model
200×100	149	200×90	139	200×80	109	200×70	119
180×100	150	180×90	140	180×80	110	170×70	120
160×100	151	160×90	141	160×80	111	160×70	121
140×100	154	140×90	144	140×80	114	140×70	124
120×100	152	120×90	142	120×80	112	120×70	122
100×100	155	100×90	145	100×80	115	100×70	125
				80×80	113	80×70	123
not / nicht / nelze: Standard line						not / nicht / nelze: Standard line	

(cm)	model	X (cm)	R	model	X (cm)	R	model	X (cm)	R	model	X (cm)	R	model
200×60	129	200×110		909	200×110		809	200×110		509	200×110		509
160×60	130	180×110		910	180×110		810	180×110		510	180×110		510
160×60	131	160×110		911	160×110		811	160×110		511			
140×60	134												
120×60	132												
100×60	135												
80×60	133												
not / nicht / nelze: NQA													

X (cm)	R	model	X (cm)	R	model	X (cm)	R	model	X (cm)	R	model	X (cm)	R	model
200×110		409	200×90		189	200×90		609	200×90		629	180×90		610
180×110		410	180×90		190	180×90		611	180×90		630	160×90		631
160×110		411	160×90		191	160×90		614	160×90		634	140×90		634
			140×90		194									

X (cm)	R	model	X (cm)	R	model	X (cm)	model	X/Y/Z (cm)	model
200×90		159	200×90		179	200×100	169	180/90/90	650
180×90		160	180×90		180	180×100	170	160/80/80	651
160×90		161	160×90		181	160×100	171	140/70/70	654
140×90		164	140×90		184	140×100	174	120/60/60	652
						not / nicht / nelze: Standard line		not / nicht / nelze: NQA(model 652), Standard line	

X (cm)	model
180×90	770
160×90	771
140×90	774
not / nicht / nelze: NQA, NCV, NCR	

X (cm)	model
260×120	766
240×120	767
220×120	768
200×120	769
180×120	760
not / nicht / nelze: NQA, NCV, NCR, Standard line (model 766)	

X (cm)	R	model
216×120		479
196×120		480
176×120		481
not / nicht / nelze: NSV, NSR, Standard line		

X (cm)	R	model
216×113		489
196×113		490
176×113		491
not / nicht / nelze: NSV, NSR, Standard line		

X×Y (cm)	R	model
200×180		217
200×160		215
200×140		213
200×120		211
180×180		277
180×160		275
180×140		273
180×120		271
160×180		257
160×160		255
160×140		253
160×120		251
140×180		237
140×160		235
140×140		233
140×120		231
not / nicht / nelze: NSV, NSR, Standard line		

X×Y (cm)	R	model
200×180		228
200×160		226
200×140		224
200×120		222
180×180		288
180×160		286
180×140		284
180×120		282
160×180		268
160×160		266
160×140		264
160×120		262
140×180		248
140×160		246
140×140		244
140×120		242
not / nicht / nelze: NSV, NSR, Standard line		

X (cm)	model
180×100	430
160×100	431
140×100	434
not / nicht / nelze: NCV, NCR	
(cm)	model
∅ 140	454
∅ 120	452
∅ 100	455
∅ 80	453
not / nicht / nelze: NCV, NCR	

X (cm)	model
180×80	440
160×80	441
140×80	444
not / nicht / nelze: NCV, NCR	

## Extensions / Anstellische / Přístavby ND (Design line, Smart line, Classic line), UN (Standard line)

(cm)	model
90×45	EP00
80×40	EP01

(cm)	model
180×90	EP02
160×80	EP03
182×90 *	EP04
162×80 *	EP05
* for screens / für Trennwände / pro paravány	

(cm)	R	model
R 90×90°		EP10
R 80×90°		EP11

(cm)	R	model
R 90×135°		EP12
R 80×135°		EP13

(cm)	R	model
118×127 (80)		EP80

(cm)	R	model
156×90		EP60
136×80		EP61

(cm)	R	model
∅ 130 (90)		EP30
∅ 110 (90)		EP31
∅ 130 (80)		EP32
∅ 110 (80)		EP33

(cm)	model
∅ 120 (90)	EP20
∅ 100 (90)	EP21
∅ 120 (80)	EP22
∅ 100 (80)	EP23



(cm)	R	model	(cm)	R	model	(cm)	R	model
∅ 150 × 270° (90)		EP14	100 × 90		EP34	135 × 90		EP70
∅ 120 × 270° (80)		EP15	90 × 80		EP35	120 × 80		EP71
						120 × 60		EP72

(cm)	model	(cm)	model
180 × 60	EP40	180 × 60	EP50
160 × 60	EP41	160 × 60	EP51
180 × 40	EP42	180 × 40	EP52
160 × 40	EP43	160 × 40	EP53
182 × 60 *	EP44	182 × 60 *	EP54
162 × 60 *	EP45	162 × 60 *	EP55
182 × 40 *	EP46	182 × 40 *	EP56
162 × 40 *	EP47	162 × 40 *	EP57

\* for screens / für Trennwände / pro paravány

**Connecting parts / Zwischenplatten / Spojovací díly ND (Design line, Smart line, Classic line), UN (Standard line)**

(cm)	model	(cm)	model	(cm)	model	(cm)	model
90-90/90°	ES00	90-90/60°	ES10	90-90/45°	ES20	90-90/90°	ES30
80-80/90°	ES01	80-80/60°	ES11	80-80/45°	ES21	80-80/90°	ES31
60-60/90°	ES02	60-60/60°	ES12	60-60/45°	ES22	60-60/90°	ES32
90-80/90°	ES03	90-80/60°	ES13	90-80/45°	ES23	90-80/90°	ES33
80-60/90°	ES04	80-60/60°	ES14	80-60/45°	ES24	80-60/90°	ES34

(cm)	model	(cm)	model	(cm)	model
90-90/60°	ES40	90-90/45°	ES50	90-90/90°	ES80
80-80/60°	ES41	80-80/45°	ES51	80-80/90°	ES81
60-60/60°	ES42	60-60/45°	ES52	60-60/90°	ES82
90-80/60°	ES43	90-80/45°	ES53	90-80/90°	ES83
80-60/60°	ES44	80-60/45°	ES54	80-60/90°	ES84

(cm)	model	(cm)	model
90-90/120°	ES90	90-90/90°	ES95
80-80/120°	ES91	80-80/90°	ES96
60-60/120°	ES92	60-60/90°	ES97

**BENCH Design line NQV, NQA Smart line NVV, NVR**

**Desks / Tische / Stoly**

(cm)	model	(cm)	model	(cm)	model
2 × 180 × 80	881	4 × 180 × 80	882	2 × 180 × 80	886
2 × 160 × 80	681	4 × 160 × 80	682	2 × 160 × 80	686
2 × 140 × 80	481	4 × 140 × 80	482	2 × 140 × 80	486
2 × 180 × 70	871	4 × 180 × 70	872	2 × 180 × 70	876
2 × 160 × 70	671	4 × 160 × 70	672	2 × 160 × 70	676
2 × 140 × 70	471	4 × 140 × 70	472	2 × 140 × 70	476
2 × 180 × 60	861	4 × 180 × 60	862	2 × 180 × 60	866
2 × 160 × 60	661	4 × 160 × 60	662	2 × 160 × 60	666
2 × 140 × 60	461	4 × 140 × 60	462	2 × 140 × 60	466

(cm)	model	(cm)	model
6 × 180 × 80	883	3 × 180 × 80	887
6 × 160 × 80	683	3 × 160 × 80	687
6 × 140 × 80	483	3 × 140 × 80	487
6 × 180 × 70	873	3 × 180 × 70	877
6 × 160 × 70	673	3 × 160 × 70	677
6 × 140 × 70	473	3 × 140 × 70	477
6 × 180 × 60	863	3 × 180 × 60	867
6 × 160 × 60	663	3 × 160 × 60	667
6 × 140 × 60	463	3 × 140 × 60	467

(cm)	model	(cm)	model	(cm)	model
260 × 120	711	260 × 160	731	2 × 220 × 160	735
240 × 120	712	240 × 160	732	2 × 200 × 160	736
220 × 120	713	220 × 160	733	2 × 180 × 160	737
200 × 120	714	200 × 160	734	2 × 160 × 160	738
260 cm – middle leg / Mittelfuß / středové nohy		260 cm – middle leg / Mittelfuß / středové nohy		2 × 220 × 140	725
				2 × 200 × 140	726
				2 × 180 × 140	727
				2 × 160 × 140	728

(cm)	model	(cm)	model	(cm)	model
260 × 100	701	260 × 140	721	2 × 220 × 120	715
240 × 100	702	240 × 140	722	2 × 200 × 120	716
220 × 100	703	220 × 140	723	2 × 180 × 120	717
200 × 100	704	200 × 140	724	2 × 160 × 120	718
260 cm – middle leg / Mittelfuß / středové nohy		260 cm – middle leg / Mittelfuß / středové nohy		2 × 220 × 100	705
				2 × 200 × 100	706
				2 × 180 × 100	707
				2 × 160 × 100	708



**Manager line** NMO, NMU

**Desks / Tische / Stoly**

(cm)	model	(cm)	model	(cm)	model
200×100	149	200×90	139	200×80	109
180×100	150	180×90	140	180×80	110
160×100	151	160×90	141	160×80	111
140×100	154	140×90	144	140×80	114

**Desks for extensions / Tische zu Anstellischen / Stoly pro přístavby / NMO, NMU**

(cm)	model	(cm)	model	(cm)	model
200×100	249	200×90	239	200×80	209
180×100	250	180×90	240	180×80	210
160×100	251	160×90	241	160×80	211
140×100	254	140×90	244	140×80	214

**Desks for base cabinets / Tische zu Unterschränken / Stoly k podstavným skříním / NMO, NMU**

(cm)	model	(cm)	model	(cm)	model
200×100	349	200×90	339	200×80	309
180×100	350	180×90	340	180×80	310
160×100	351	160×90	341	160×80	311
140×100	354	140×90	344	140×80	314

**Wood line** NWU, NWA

(cm)	model	(cm)	model	X (cm)	model
180×80	110	275×100	709	180×90	770
160×80	111	220×100	703	160×90	771
140×80	114	200×100	704		
120×80	112				
100×80	115				
80×80	113				

**Extensions / Anstellische / Přístavby**

(cm)	model
120×60	412
140×60	414
160×60	416

**Base cabinets / Unterschränke / Podstavné skříně NMA**

(cm)	height / Höhe / výška: 64 cm	R	model
200×52			NMA 200 52
190×52			NMA 190 52
180×52			NMA 180 52

**Solid line** CAB

**Work desks / Arbeitstische / Pracovní stoly / CABP**

(cm)	model
200×80	109
180×80	110
160×80	111
140×80	114
120×80	112
100×80	115
80×80	113

**Desks with drawer / Tische mit Container / Stoly s kontejnerem / CABK**

(cm)	R	model *
200×80		109 B271 109 B272 109 B275
180×80		110 B271 110 B272 110 B275
160×80		111 B271 111 B272 111 B275

\* by container type / nach Containertyp / dle typu kontejneru

**Meeting desks / Besprechungstische / Jednací stoly / CABJ**

(cm)	model	(cm)	model
200×100	149	200×80	109
180×100	150	180×80	110
160×100	151	160×80	111
140×100	154	140×80	114

**Desks for base cabinet / Tische für Unterschrank / Stoly pro podstavnou skřín / CABS**

(cm)	R	model *
220×80		108 B271 108 B272 108 B275
200×80		109 B271 109 B272 109 B275

\* by container type / nach Containertyp / dle typu kontejneru

**Base cabinet / Unterschrank / Podstavná skřín / CAA**

(cm)	height / Höhe / výška: 72 cm	R	model
160×46			CAA 160 46

**Meeting line** NQB, NQP, NWB

**Desks / Tische / Stoly / NQB**

(cm)	height / Höhe / výška: 110 cm	model	(cm)	height / Höhe / výška: 110 cm	model	(cm)	height / Höhe / výška: 110 cm	model
200×100	149	200×90	139	200×80	109			
180×100	150	180×90	140	180×80	110			
160×100	151	160×90	141	160×80	111			

**Desks with panel / Tische mit Paneel / Stoly s panelem / NQP**

(cm)	height / Höhe / výška: 110 cm	model	(cm)	height / Höhe / výška: 110 cm	model	(cm)	height / Höhe / výška: 110 cm	model
200×100	149	200×90	139	200×80	109			
180×100	150	180×90	140	180×80	110			
160×100	151	160×90	141	160×80	111			

height panel / Höhe Paneel / výška panelu: 190 cm



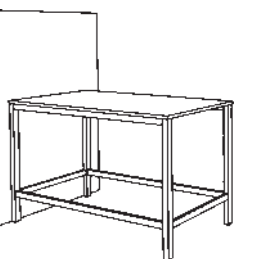
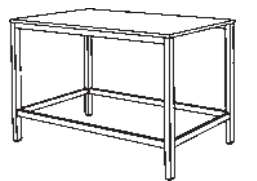

height panel / Höhe Paneel / výška panelu: 190 cm

height panel / Höhe Paneel / výška panelu: 190 cm



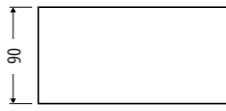
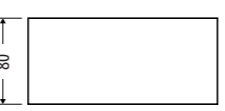

### Desks / Tische / Stoly / NWB

(cm)	height / Höhe / výška: 110 cm	model	(cm)	height / Höhe / výška: 110 cm	model	(cm)	height / Höhe / výška: 110 cm	model
180 × 100		150	180 × 90		140	180 × 80		110
160 × 100		151	160 × 90		141	160 × 80		111

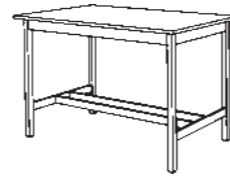









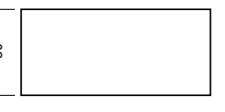
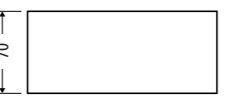
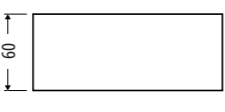

### Hotcom SFB, SFC, SFA, SFE, SFS, SFL, SFT

#### SFB - Hotcom

#### SFC - Hotcom with shelf / mit Ablagefach / s policí

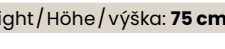
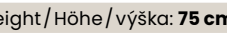

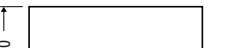
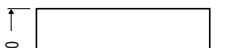

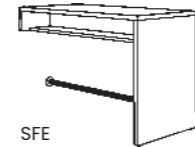
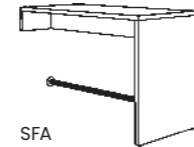
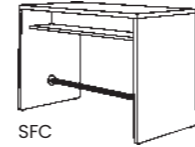
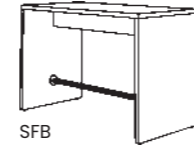

#### SFA - Hotcom wall mounting / Wandmontage / přístavný

#### SFE - Hotcom wall mounting with shelf / Wandmontage mit Ablagefach / přístavný s policí

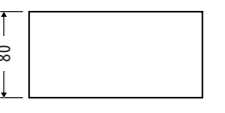
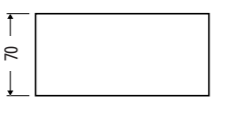
(cm)	height / Höhe / výška: 105 cm	model	(cm)	height / Höhe / výška: 105 cm	model	(cm)	height / Höhe / výška: 105 cm	model
200 × 80		208	200 × 70		207	200 × 60		206
180 × 80		188	180 × 70		187	180 × 60		186
160 × 80		168	160 × 70		167	160 × 60		166
140 × 80		148	140 × 70		147	140 × 60		146
120 × 80		128	120 × 70		127	120 × 60		126

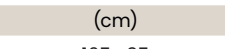

#### SFS - Hotcom low / niedrig / nízký

(cm)	height / Höhe / výška: 75 cm	model	(cm)	height / Höhe / výška: 75 cm	model
180 × 80		188	180 × 70		187
160 × 80		168	160 × 70		167
140 × 80		148	140 × 70		147
120 × 80		128	120 × 70		127

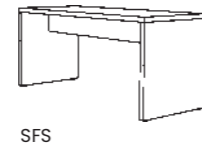

#### SFL - Bench / Sitzbank / Lavice

(cm)	model
165 × 35	165
145 × 35	145
125 × 35	125
105 × 35	105
upholstered seat / gepolsterter Sitzkissen / čalouněný sedák for bench / für Sitzbank / pro lavici 105, 125, 145 cm	SE2
upholstered seat / gepolsterter Sitzkissen / čalouněný sedák for bench / für Sitzbank / pro lavici 165 cm	SE3

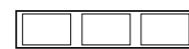
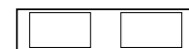
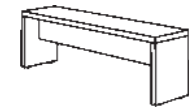

#### SFT - Tabourets / Sitzwürfel / Taburety

	model
full upholstered / vollgepolstert / celočalouněný 45 × 45 × 45 cm	245
upholstered seat, laminate / gepolsterter Sitzkissen, Laminat / čalouněný sedák, laminát 45 × 45 × 45 cm	345

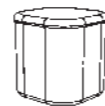

### Desks with round base / Tische mit rundem Gestell / Stoly s kruhovou podstavou CRB

desk / Platte / deska (cm)	model	height / Höhe / výška (cm)		base / Gestell / podstava (cm)	
		B/C	F	B/C	F
	Ø 120	452	75/72	-	Ø 64
	Ø 100	455	75/72	110	Ø 64
	Ø 80	453	75/72	110	Ø 64
	Ø 60	456	75/72	110	Ø 64

leg / Fuß / noha: Ø 8 cm

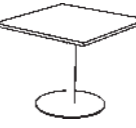
desk / Platte / deska (cm)	model	height / Höhe / výška (cm)		base / Gestell / podstava (cm)	
		B/C	F	B/C	F
	90 × 90	147	75/72	-	Ø 64
	80 × 80	113	75/72	110	Ø 49
	60 × 60	136	75/72	110	Ø 49

leg / Fuß / noha: Ø 8 cm

### Desks with square base / Tische mit viereckigem Gestell / Stoly s čtvercovou podstavou CSB

desk / Platte / deska (cm)	model	height / Höhe / výška (cm)		base / Gestell / podstava (cm)	
		B/C	F	B/C	F
	Ø 120	452	75/72	-	60 × 60
	Ø 100	455	75/72	110	60 × 60
	Ø 80	453	75/72	110	48 × 48
	Ø 60	456	75/72	110	48 × 48

leg / Fuß / noha: 8 × 8 cm

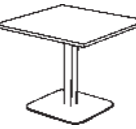
desk / Platte / deska (cm)	model	height / Höhe / výška (cm)		base / Gestell / podstava (cm)	
		B/C	F	B/C	F
	90 × 90	147	75/72	-	60 × 60
	80 × 80	113	75/72	110	48 × 48
	60 × 60	136	75/72	110	48 × 48

leg / Fuß / noha: 8 × 8 cm

### Desks with round base 80 cm / Tische mit rundem Gestell 80 cm / Stoly s kruhovou podstavou 80 cm NJC

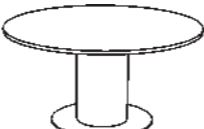
desk / Platte / deska (cm)	model	height / Höhe / výška (cm)	base / Gestell / podstava (cm)	
			B/C	
	Ø 160	451	75	Ø 80
	Ø 150	458	75	Ø 80

leg / Fuß / noha: Ø 40 cm

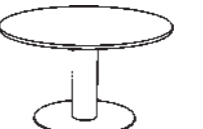
desk / Platte / deska (cm)	model	height / Höhe / výška (cm)	base / Gestell / podstava (cm)	
			B/C	
	Ø 140	454	75	Ø 80
	Ø 130	457	75	Ø 80

leg / Fuß / noha: Ø 19,3 cm



# Electric desks / Elektrotische / Elektrické stoly

## Electric line ELK

three-segment, dual-motor / dreisegment, zwei Motoren / třísegment, dvoumotorový

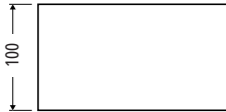
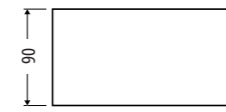
(cm)	height / Höhe / výška: 63–128 cm	model	(cm)	height / Höhe / výška: 63–128 cm	model
200×100		149	200×90		139
180×100		150	180×90		140
160×100		151	160×90		141
			140×90		144

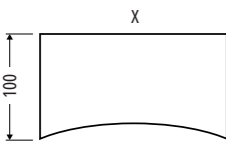
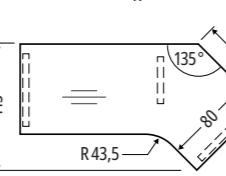
X (cm)	height / Höhe / výška: 63–128 cm	model	X (cm)	height / Höhe / výška: 63–128 cm	R	model
200×100		169	216×113			489
180×100		170	196×113			490
160×100		171	176×113			491

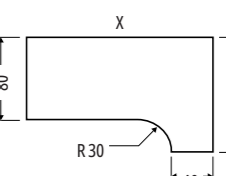
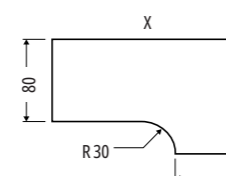
X (cm)	height / Höhe / výška: 63–128 cm	R	model	X (cm)	height / Höhe / výška: 63–128 cm	R	model
200×110			509	200×110			409
180×110			510	180×110			410
160×110			511	160×110			411

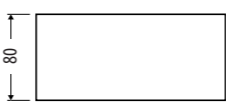
(cm)	height / Höhe / výška: 63–128 cm	model
200×80		109
180×80		110
160×80		111
140×80		114
120×80		112

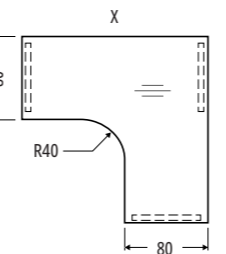
X×Y (cm)	height / Höhe / výška: 63–128 cm	R	model
200×180			228
200×160			226
180×180			288
180×160			286

## Electric line ELM

three-segment, dual-motor / dreisegment, zwei Motoren / třísegment, dvoumotorový

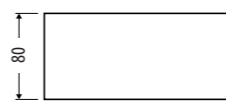
(cm)	height / Höhe / výška: 61–126 cm	model
200×80		109
180×80		110
160×80		111
140×80		114
120×80		112

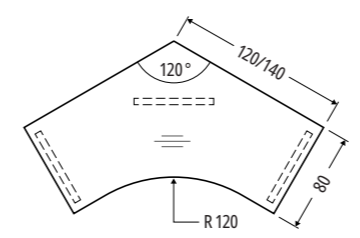
X×Y (cm)	height / Höhe / výška: 61–126 cm	model
243×139/140×140		344
208×129/120×120		322

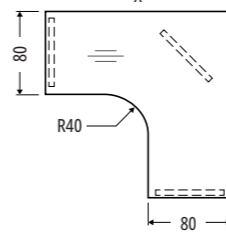
X×Y (cm)	height / Höhe / výška: 61–126 cm	R	model
180×180			288
180×160			286
180×140			284
160×160			266
160×140			264

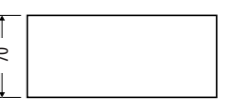
(cm)	height / Höhe / výška: 61–126 cm	model
200×70		119
180×70		120
160×70		121
140×70		124
120×70		122

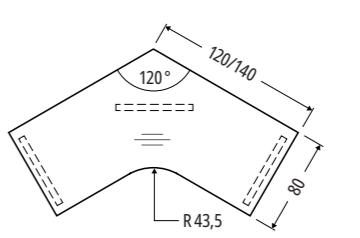
X×Y (cm)	height / Höhe / výška: 61–126 cm	model
243×139/140×140		444
208×129/120×120		422

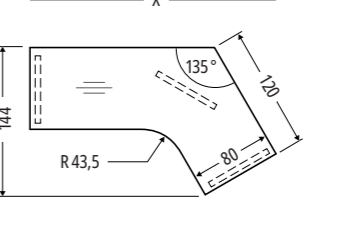
X (cm)	height / Höhe / výška: 61–126 cm	R	model
240×144			482
220×144			462
200×144			442

## Electric office desks on central base / Elektrotische auf Zentralfüßen / Elektrické stoly na centrálních nohách

ELC, ELD

three-segment, dual-motor / dreisegment, zwei Motoren / třísegment, dvoumotorový

(cm)	height / Höhe / výška: 57–123 cm	model
∅ 100		ELC 455
∅ 80	base plate Gestell Teller podstava talíř ∅ 64	ELC 453
∅ 60		ELC 456

(cm)	height / Höhe / výška: 63–129 cm	model
∅ 80		ELD 453
∅ 60	base cross Gestell Kreuz podstava kříž 67×67 cm	ELD 456



# Cabinets KN / Schränke KN / Skříně KN

- Ⓐ Open bookcases Ⓑ Double door cabinets Ⓒ Wardrobes with division Ⓓ Wardrobes Ⓔ Combined cabinets Ⓕ File cabinets/Combined file cabinets Ⓖ Drawer cabinets
- Ⓛ Lockers Ⓝ Sliding door cabinets Ⓟ Cabinets with tambour door into the back wall Ⓡ Tambour cabinets Ⓢ Tambour with roller mechanism Ⓣ Corner cabinets
- Ⓩ Hanging cabinets ■ optional with glass doors, without lock – the image of single door cabinets is right version
- Ⓐ Offene Regale Ⓑ Drehtürschränke Ⓒ Kleiderschränke mit Inneneinteilung Ⓓ Kleiderschränke Ⓔ Kombischränke Ⓕ Hängeregistratorschränke/Kombihängeregistratorschränke
- Ⓛ Schränke mit Schubladen Ⓝ Lockerschränke Ⓝ Schiebetürschränke Ⓟ Schränke mit Rollläden hinter die Rückwand Ⓡ Querrollladenschränke Ⓢ Rollladenschränke mit Aufrollmechanismus
- Ⓣ Eckschränke Ⓩ Hängeschränke ■ mit Glastür möglich, ohne Schloss – Abbildung eintüriger Schränke ist rechte Ausführung
- Ⓐ Otevřené skříně Ⓑ Skříně s křídlovými dveřmi Ⓒ Šatní skříně s vnitřním členěním Ⓓ Šatní skříně Ⓔ Kombinované skříně Ⓕ Kartotékové skříně/Kombinované kartotékové skříně
- Ⓛ Zásuvkové skříně Ⓝ Lockerové skříně Ⓝ Skříně s posuvnými dveřmi Ⓟ Skříně s roletou za záda Ⓡ Skříně s roletou se šnekem Ⓢ Skříně s roletou s navijecím mechanismem Ⓣ Rohové skříně
- Ⓩ Závěsné skříně ■ možnost se skleněnými dveřmi, bez zámku – vyobrazení jednokřídlých skříní je pravé

## 1 OH height/Höhe/výška: 37,5 cm

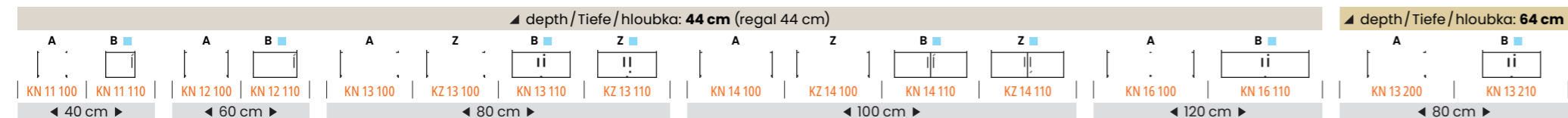

## 2 OH height/Höhe/výška: 75 cm

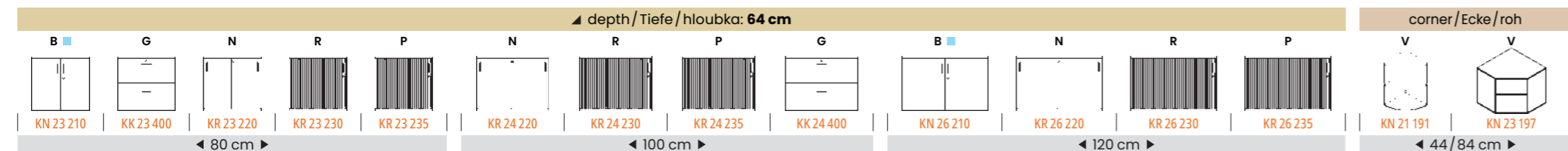
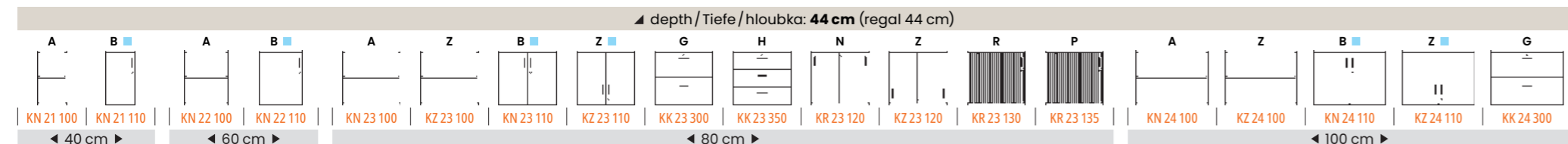

## P OH height/Höhe/výška: 72 cm

## Juxtaposed cabinets / Anstellschränke / Přístavné skříně

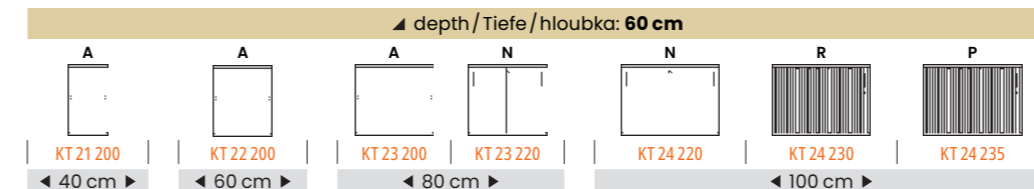
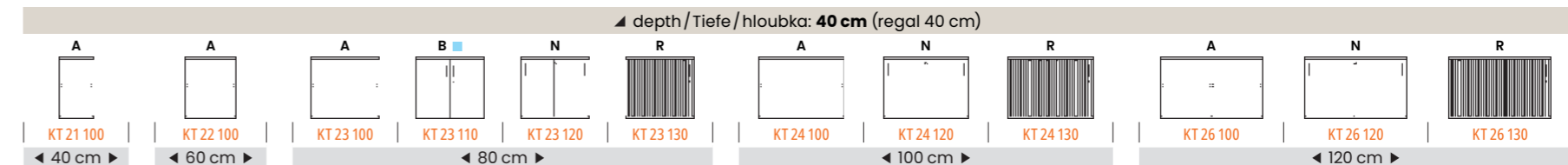

## 3 OH height/Höhe/výška: 112,5 cm

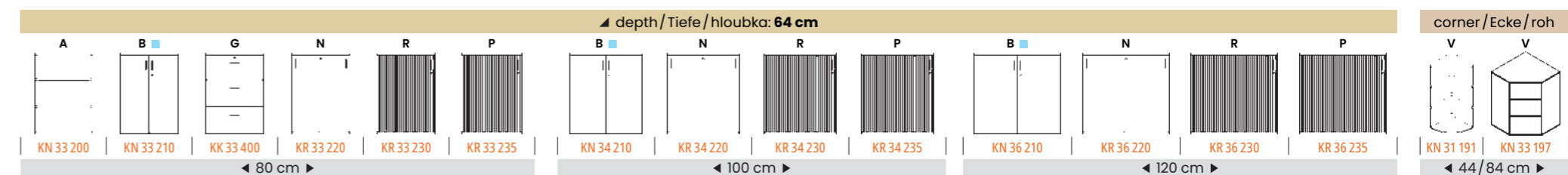
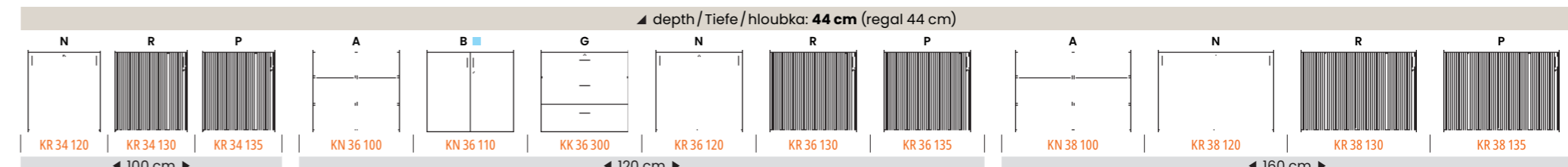
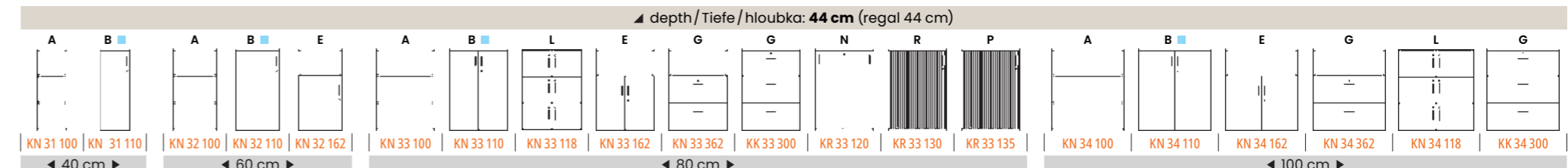



**4 OH** height/Höhe/výška: **150 cm**

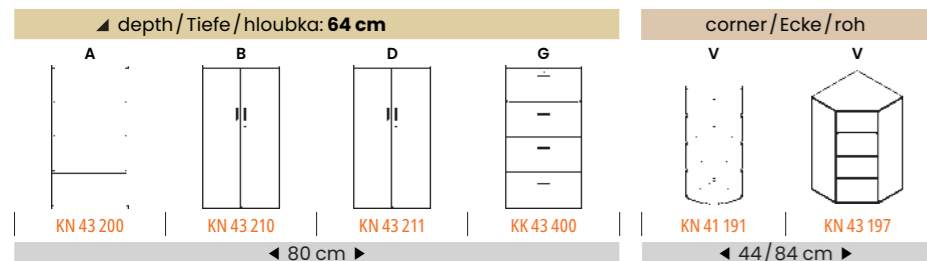
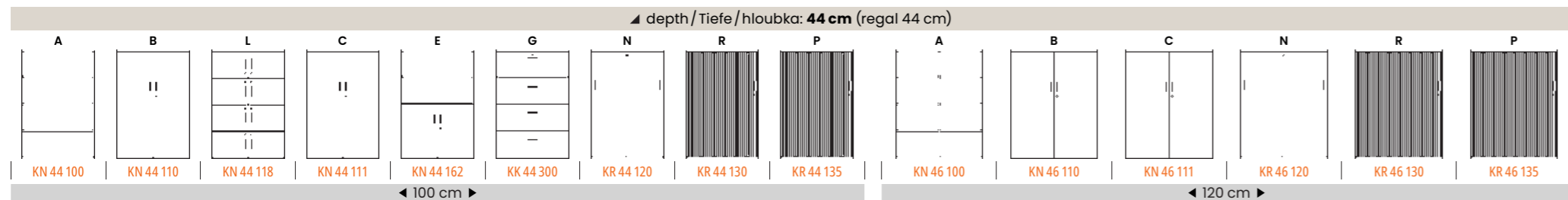
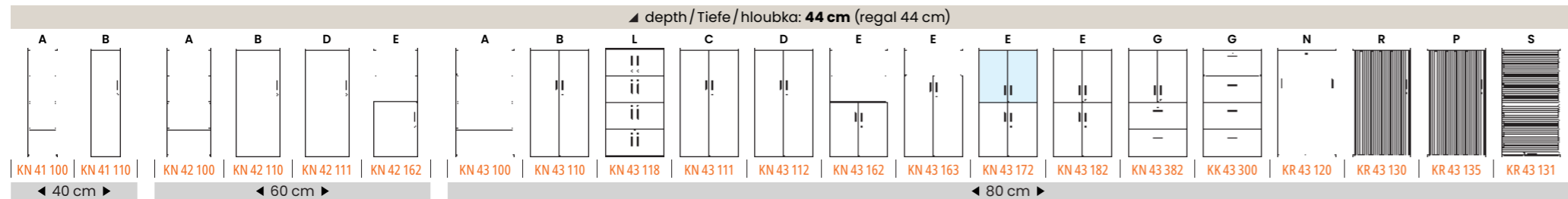

**5 OH** height/Höhe/výška: **187,5 cm**

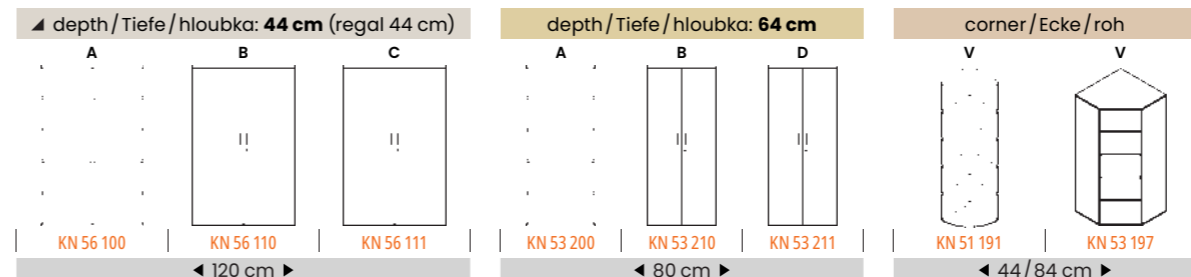
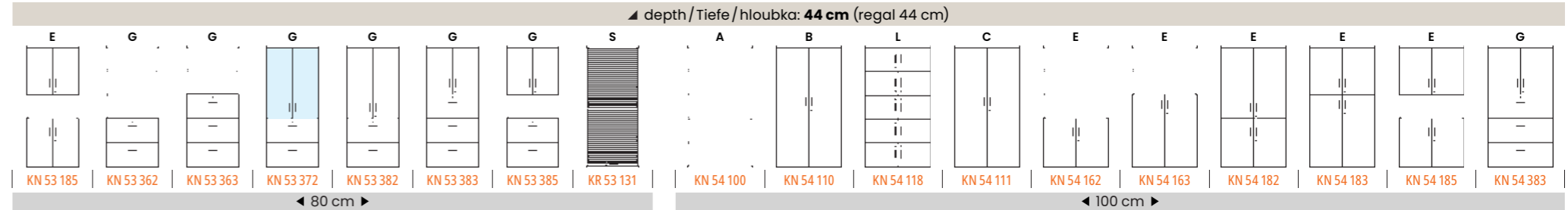
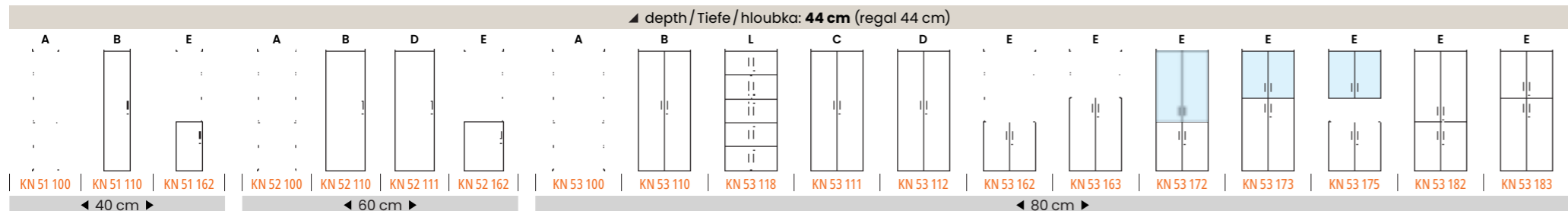

**6 OH** height/Höhe/výška: **225 cm**

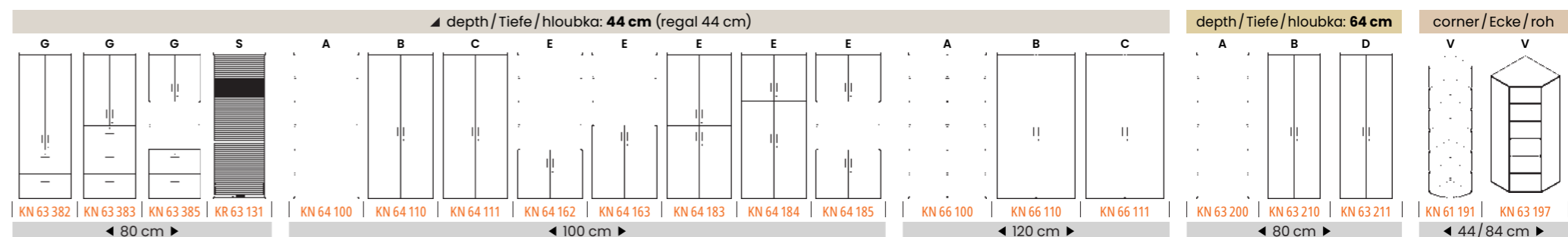
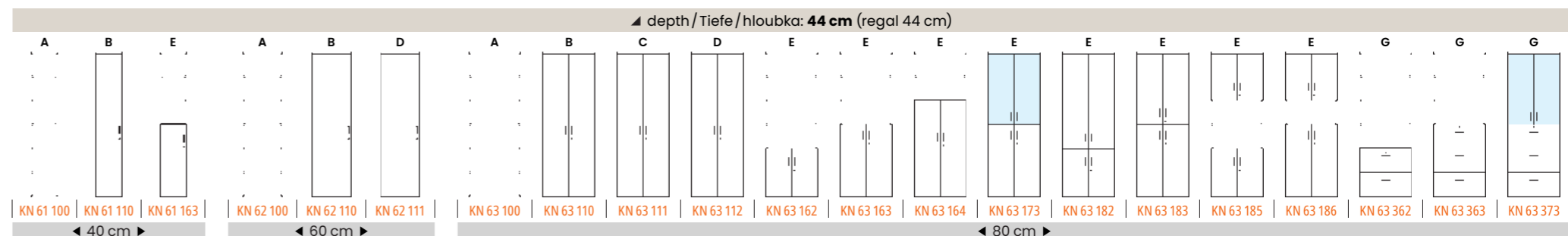



# Cabinets SN / Schränke SN / Skříně SN

Ⓐ Open bookcases Ⓑ Double door cabinets Ⓒ Wardrobes with division Ⓓ Wardrobes Ⓔ Combined cabinets Ⓕ File cabinets / Combined file cabinets Ⓖ Drawer cabinets Ⓗ Lockers Ⓘ Sliding door cabinets Ⓡ Tambour cabinets Ⓢ Tambour with roller mechanism Ⓣ Corner cabinets Ⓤ Hanging cabinets ■ optional with glass doors, without lock – the image of single door cabinets is right version

Ⓐ Offene Regale Ⓑ Drehtürschränke Ⓒ Kleiderschränke mit Inneneinteilung Ⓓ Kleiderschränke Ⓔ Kombischränke Ⓕ Hängeregistraturschränke / Kombihängeregistraturschränke Ⓗ Schränke mit Schubladen Ⓖ Lockerschränke Ⓘ Schiebetürenschränke Ⓡ Querrolladenschränke Ⓢ Rolladenschränke mit Aufrollmechanismus Ⓣ Eckschränke Ⓤ Hängeschränke ■ mit Glastür möglich, ohne Schloss – Abbildung eintüriger Schränke ist rechte Ausführung

Ⓐ Otevřené skříně Ⓑ Skříně s křídlovými dveřmi Ⓒ Šatní skříně s vnitřním členěním Ⓓ Šatní skříně Ⓔ Kombinované skříně Ⓕ Kartotékové skříně / Kombinované kartotékové skříně Ⓗ Zásuvkové skříně Ⓖ Lockerové skříně Ⓘ Skříně s posuvnými dveřmi Ⓡ Skříně s roletou se šnekem Ⓢ Skříně s roletou s navijecím mechanismem Ⓣ Rohové skříně Ⓤ Závěsné skříně ■ možnost se skleněnými dveřmi, bez zámku – vyobrazení jednokřídlových skříní je pravé

## 1 OH height/Höhe/výška: 37,1 cm

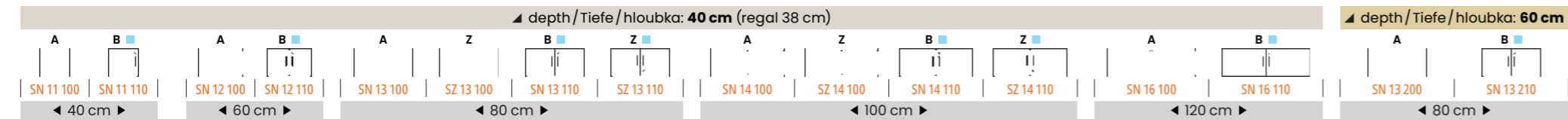

## 2 OH height/Höhe/výška: 72,3 cm

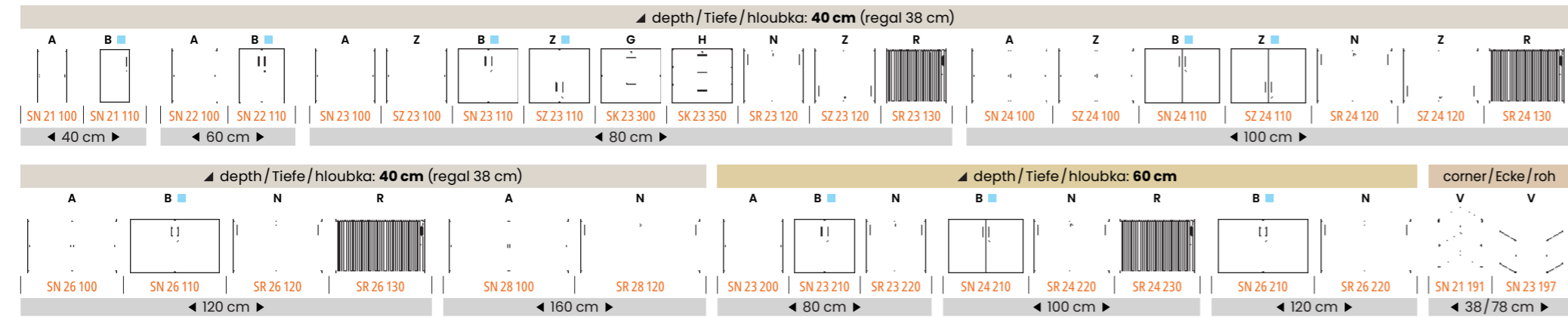

## POH height/Höhe/výška: 75 cm Juxtaposed cabinets / Anstellschränke / Přistavné skříně

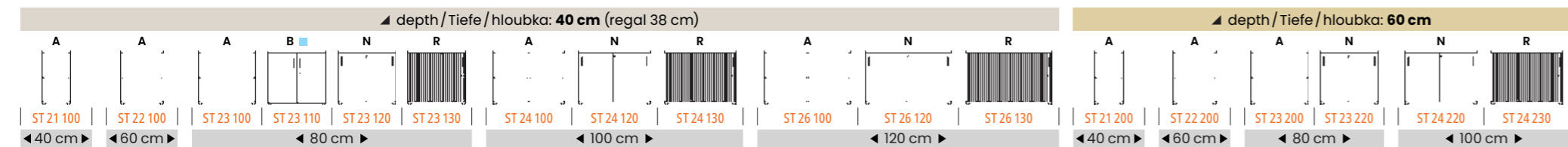

## 3 OH height/Höhe/výška: 107,5 cm

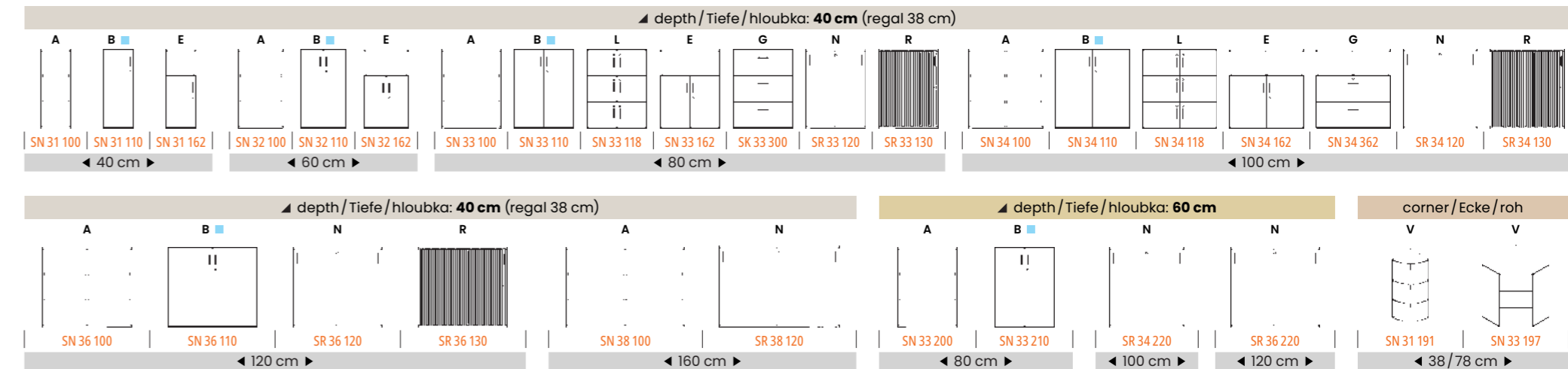

## 4 OH height/Höhe/výška: 142,7 cm

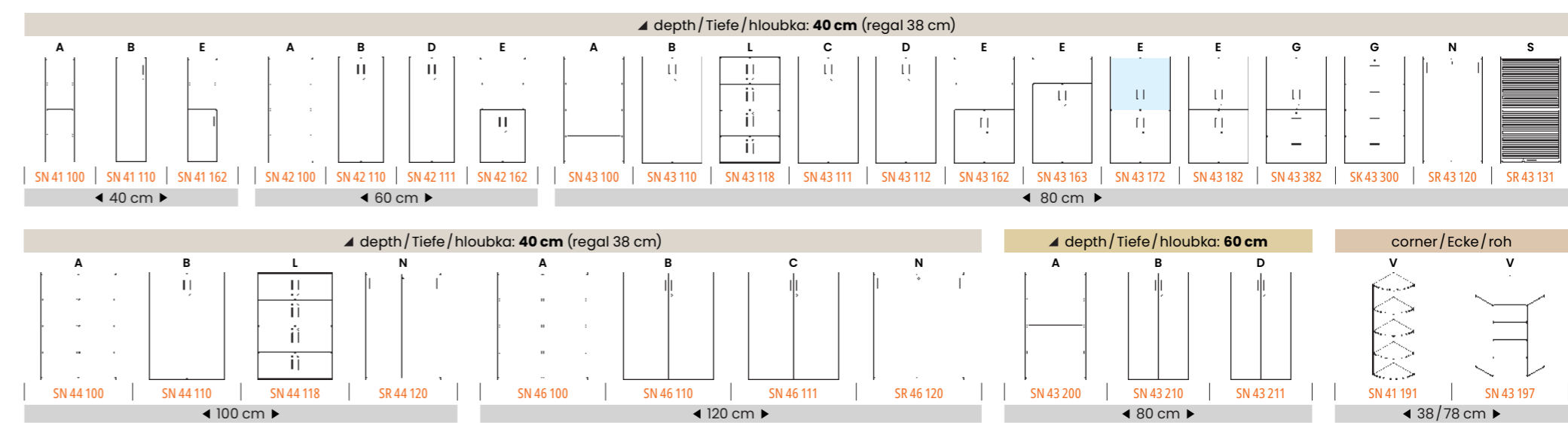



**5 OH** height/Höhe/výška: **177,9 cm**

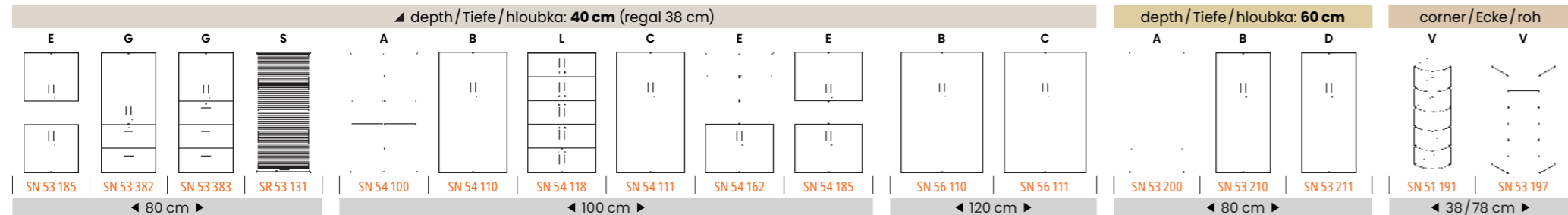
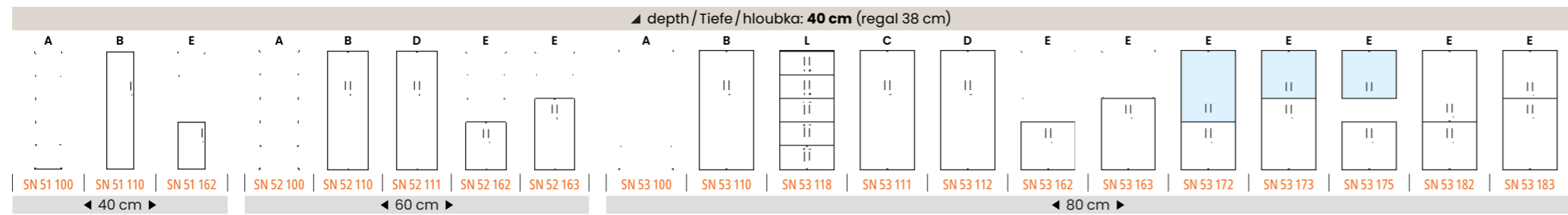

**6 OH** height/Höhe/výška: **213,1 cm**

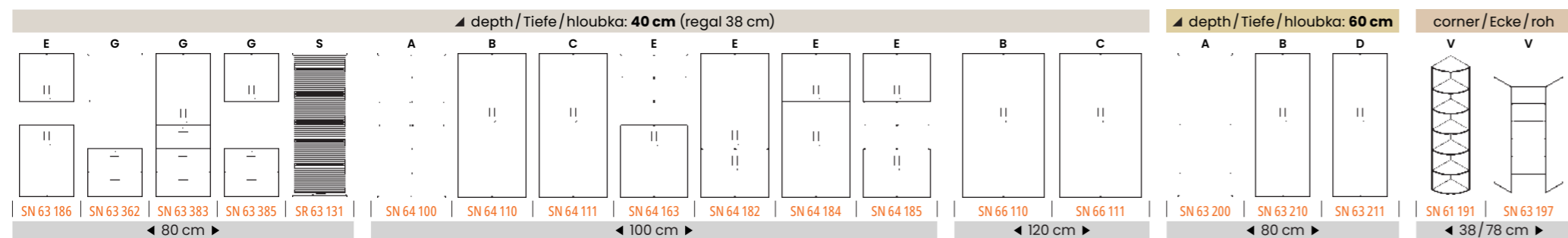
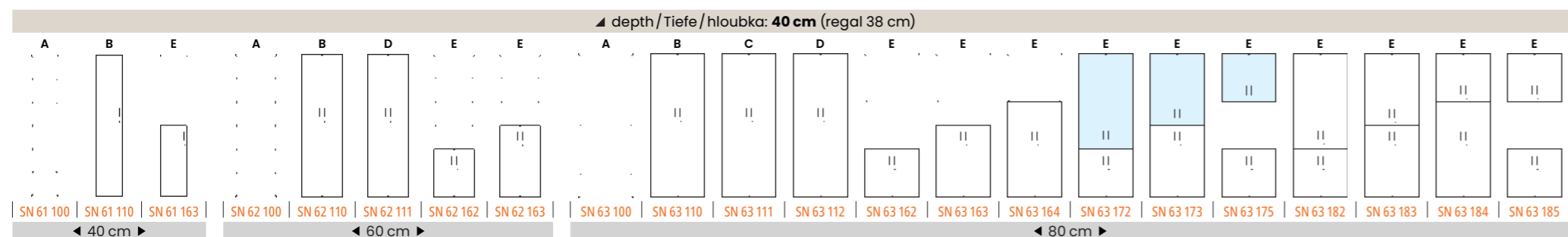

**Cabinets SD / Schränke SD / Skříně SD**

Ⓐ Open bookcases Ⓑ Double door cabinets Ⓒ Wardrobes with division Ⓓ Wardrobes Ⓔ Combined cabinets – the image of single door cabinets is right version  
 Ⓐ Offene Regale Ⓑ Drehtürschränke Ⓒ Kleiderschränke mit Inneneinteilung Ⓓ Kleiderschränke Ⓔ Kombischränke – Abbildung eintüriger Schränke ist rechte Ausführung  
 Ⓐ Otevřené skříně Ⓑ Skříně s křídlovými dveřmi Ⓒ Šatní skříně s vnitřním členěním Ⓓ Šatní skříně Ⓔ Kombinované skříně – vyobrazení jednokřídlových skříní je pravé

**Cover panels / Abdeckplatten / Obkladové desky L x 40 x 1,9 cm**

L	model	L	model	L	model
120 cm	KH12	124 cm	KU12	122 cm	KL12
160 cm	KH16	164 cm	KU16	162 cm	KL16
200 cm	KH20	204 cm	KU20	202 cm	KL20
240 cm	KH24	244 cm	KU24	242 cm	KL24

L	model	L	model
2 OH	SE07	2 OH	SM07
3 OH	SE11	3 OH	SM11
4 OH	SE14	4 OH	SM14
5 OH	SE18	5 OH	SM18

only version with plinth 40 mm / nur Variante mit Sockel 40 mm / jen varianta se soklem 40 mm

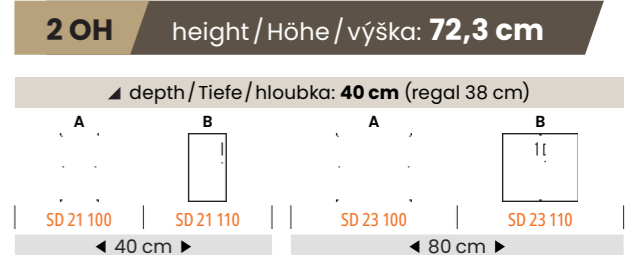

**3 OH** height/Höhe/výška: **107,5 cm**

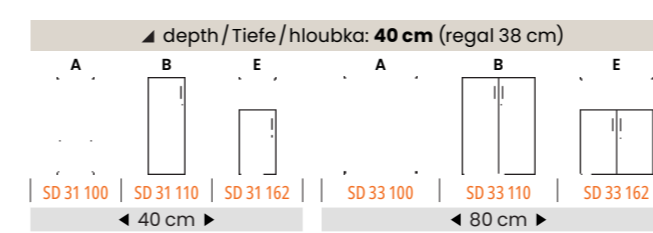

**4 OH** height/Höhe/výška: **142,7 cm**

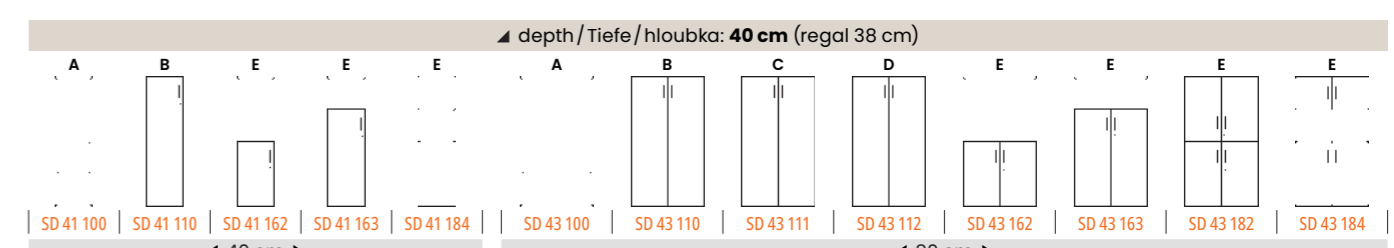

**5 OH** height/Höhe/výška: **177,9 cm**

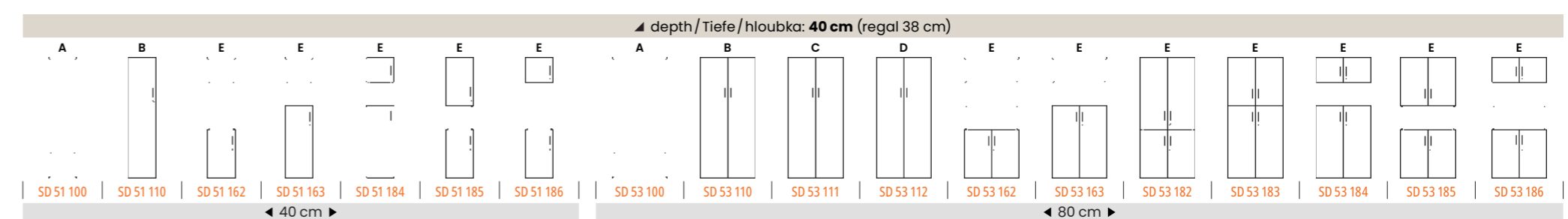



# Drawer units / Container / Kontejnery

## Drawer units with grip / Container mit Griffen / Kontejnery s úchytkou

depth / Tiefe / hloubka: **60 cm**

h = <b>53,6 cm</b>			on castors / auf Rollen / na kolečkách / h = <b>59,4 cm</b>				on glides / auf Gleitern / na kluzácích / h = <b>56,9 cm</b>				

depth / Tiefe / hloubka: **80 cm**

h = <b>53,6 cm</b>			on castors / auf Rollen / na kolečkách / h = <b>59,4 cm</b>				on glides / auf Gleitern / na kluzácích / h = <b>56,9 cm</b>				

## Drawer units with lateral mount / Container mit Seitenschlitzen / Kontejnery s bočním úchytem

depth / Tiefe / hloubka: **60 cm**

h = <b>53,6 cm</b>			on castors / auf Rollen / na kolečkách / h = <b>59,4 cm</b>				on glides / auf Gleitern / na kluzácích / h = <b>56,9 cm</b>				

depth / Tiefe / hloubka: **80 cm**

h = <b>53,6 cm</b>			on castors / auf Rollen / na kolečkách / h = <b>59,4 cm</b>				on glides / auf Gleitern / na kluzácích / h = <b>53,6 cm</b>				

## Desk extension drawers with grip / Anstellcontainer mit Griffen / Přístavné kontejnery s úchytkou

depth / Tiefe / hloubka: <b>60 cm</b>			depth / Tiefe / hloubka: <b>60 cm</b>			depth / Tiefe / hloubka: <b>80 cm</b>			depth / Tiefe / hloubka: <b>80 cm</b>		
on plinth / auf Sockel / na soklu / h = <b>75 cm</b>			on glides / auf Gleitern / na kluzácích / h = <b>72 cm</b>			on plinth / auf Sockel / na soklu / h = <b>75 cm</b>			on glides / auf Gleitern / na kluzácích / h = <b>72 cm</b>		

- Ⓝ catch bolt lock    Ⓞ central lock
- Ⓝ Hebelschloss    Ⓞ Zentralschloss
- Ⓝ jazýčkový zámek    Ⓞ centrální zámek

width / Breite / šířka  
 - with grip / mit Griffen / s úchytkou: **42,3 cm**  
 - with lateral mount / mit Seitenschlitzen / s bočním úchytem: **43,9 cm**

h = height / h = Höhe / h = výška

## Desk extension drawers with lateral mount / Anstellcontainer mit Seitenschlitzen / Přístavné kontejnery s bočním úchytem

depth / Tiefe / hloubka: <b>60 cm</b>						depth / Tiefe / hloubka: <b>80 cm</b>					
on plinth / auf Sockel / na soklu / h = <b>75 cm</b>			on glides / auf Gleitern / na kluzácích / h = <b>72 cm</b>			on plinth / auf Sockel / na soklu / h = <b>75 cm</b>			on glides / auf Gleitern / na kluzácích / h = <b>72 cm</b>		

## Multipurpose / Mehrzweckcontainer / Víceúčelové

depth / Tiefe / hloubka: <b>92 cm</b>		depth / Tiefe / hloubka: <b>60 cm</b>		depth / Tiefe / hloubka: <b>44 cm</b>		depth / Tiefe / hloubka: <b>44 cm</b>	
width / Breite / šířka: <b>50 cm</b> height / Höhe / výška: <b>116 cm</b>		width / Breite / šířka: <b>100 cm</b> height / Höhe / výška: <b>57 cm</b>		width / Breite / šířka: <b>120 cm</b> height / Höhe / výška: <b>80 cm</b>		width / Breite / šířka: <b>120 cm</b> height / Höhe / výška: <b>117 cm</b>	

TV max. 50" - 113 x 65 cm

## Panel with artificial green / Paneel mit Kunstgräsern / Panel s umělou zelení

depth / Tiefe / hloubka: <b>15 cm</b>				depth / Tiefe / hloubka: <b>44 cm</b>				depth / Tiefe / hloubka: <b>38 cm</b>							
80 cm				120 cm				160 cm							
height / Höhe / výška: <b>105 cm</b>				for cabinets KN für Schränke KN pro skříně KN				for cabinets SN für Schränke SN pro skříně SN							
KN 80 440		KN 10 440		KN 12 440		KN 16 440		SN 80 380		SN 10 380		SN 12 380		SN 16 380	
80 cm		100 cm		120 cm		160 cm		80 cm		100 cm		120 cm		160 cm	
height / Höhe / výška: <b>38 cm</b>				height / Höhe / výška: <b>35 cm</b>											

# Screens / Trennwände / Paravány

## Freestanding screens in Al frame / Trennwände freistehend in Al Rahmen / Paravány volně stojící v Al rámu

Typ	width/Breite/šířka	height/Höhe/výška	PAN	PAJ	PAZ
6011X	60 cm	110 cm	•		
6012X		120 cm	•		
6014X		140 cm	•	•	•
6016X	70 cm	160 cm	•		
7011X		110 cm	•		
7012X		120 cm	•		
7014X	80 cm	140 cm	•	•	•
7016X		160 cm	•		
8011X		110 cm	•		
8012X	83 cm	120 cm	•		
8014X		140 cm	•	•	•
8016X		160 cm	•		
8311X	100 cm	110 cm	•		
8312X		120 cm	•		
8314X		140 cm	•	•	•
8316X	110 cm	160 cm	•		
1011X		110 cm	•		
1012X		120 cm	•		
1014X	120 cm	140 cm	•	•	•
1016X		160 cm	•		
1111X		110 cm	•		
1112X	130 cm	120 cm	•		
1114X		140 cm	•	•	•
1116X		160 cm	•		
1211X	140 cm	110 cm	•		
1212X		120 cm	•		
1214X		140 cm	•	•	•
1216X	160 cm	160 cm	•		
1314X		140 cm		•	•
1414X		140 cm		•	•
1614X	40 cm	140 cm		•	•
4016X		160 cm	•		
1416X		160 cm	•		
1611X	160 cm	110 cm	•		

### X = surface / Oberfläche / povrch

M – melamine / Melamin / melaminový povrch

L – fabric / Stoff / látkový povrch

P – fabric with foam layer / Stoff mit Schaumstoffschicht / látkový povrch s molitanovou vrstvou

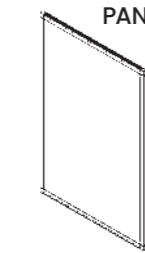

## Table screens / Tischtrennwände / Paravány stolové

model	width/Breite/šířka	height/Höhe/výška
8040X	80 cm	40 cm (u = 2,5 cm)
1040X	100 cm	
1240X	120 cm	
1440X	140 cm	
1640X	160 cm	u = under the plate / unter der Platte / pod deskou
1840X	180 cm	
2040X	200 cm	
8067X	80 cm	
1067X	100 cm	67,5 cm (u = 10 cm)
1267X	120 cm	
1467X	140 cm	
1667X	160 cm	
1867X	180 cm	u = under the plate / unter der Platte / pod deskou
2067X	200 cm	

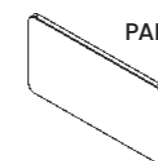
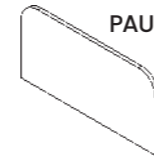
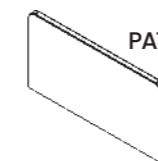
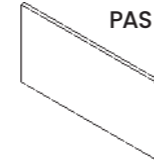
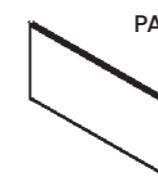
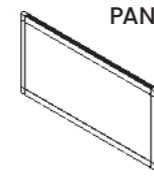

## Table screens divided / Tischtrennwände geteilt / Paravány stolové dělené

model	width/Breite/šířka	height/Höhe/výška
8040X	80 cm	40 cm (u = 2,5)
1240X	120 cm	
1440X	140 cm	
1640X	160 cm	
1840X	180 cm	u = under the plate / unter der Platte / pod deskou
2040X	200 cm	

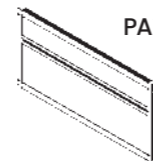

**PAN** AL profile 22 × 30 mm, top groove / obere Nut / s horní drážkou

**PAJ** AL profile 22 × 30 mm, divided with top groove / geteilt mit oberer Nut / dělené s horní drážkou

**PAZ** divided with grooves / geteilt mit Nuten / dělené s drážkami

**PAI** Al profile 20 × 20 mm

**PAS** full-fabric / stoffbespannt / celolátkový (4 × 90°)

**PAT** full-fabric / stoffbespannt / celolátkový (2 × 90°, 2 × R50)

**PAU** full-fabric / stoffbespannt / celolátkový (2 × 90°, 2 × R100)

**PAR** full-fabric / stoffbespannt / celolátkový (4 × R50)

## Freestanding screens / Trennwände freistehend / Paravány volně stojící

model	width/Breite/šířka	height/Höhe/výška
6016P	60 cm	160 cm
8016P	80 cm	
1016P	100 cm	
1316P	130 cm	

P – full upholstered with foam layer / vollgepolstert mit Schaumstoff / celočalouněné s molitanem

## Acoustic elements / Akustikelemente / Akustické prvky

### Freestanding screens / Trennwände freistehend / Paravány volně stojící

model	width/Breite/šířka	height/Höhe/výška
6015R	60 cm	150 cm
1015R	100 cm	
1315R	130 cm	

R – acoustic material Recytex with fabric / akustisches Material Recytex mit Stoff / akustický materiál Recytex s látkou

### Table screens / Tischtrennwände / Stolové paravány

model	width/Breite/šířka	height/Höhe/výška
8067R	80 cm	67,5 cm
1067R	100 cm	
1267R	120 cm	
1467R	140 cm	
1667R	160 cm	
1867R	180 cm	
2067R	200 cm	

R – acoustic material Recytex with fabric / akustisches Material Recytex mit Stoff / akustický materiál Recytex s látkou

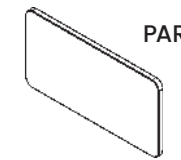
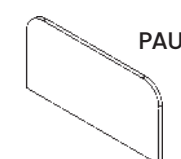
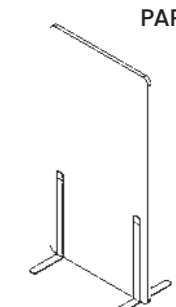
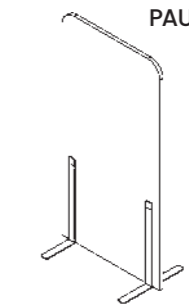
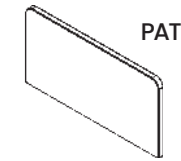
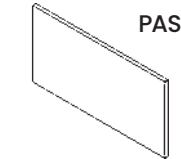
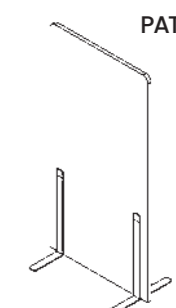
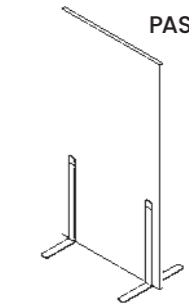

## Acoustic wall and hanging elements / Akustikelemente für Wand und Aufhängung / Akustické prvky na stěnu a zavěšení

Upholstered face sides of the panels. Acoustic material Recytex 40 mm and 25 mm. / Ansichtsseiten der Platten gepolstert. Akustisches Material Recytex 40 mm und 25 mm. / Desky čalouněné z pohledových stran. Akustický materiál Recytex 40 mm a 25 mm.

AC101	AC801	AC601	AC104	AC804	AC604	AC402	AC480	AC210
Ø 100 cm	Ø 80 cm	Ø 60 cm	Ø 100 cm	Ø 80 cm	Ø 60 cm	40 × 40 cm	40 × 80 cm	20 × 100 cm
AC102	AC802	AC602	AC103	AC803	AC603	AC840		
100 × 100 cm	80 × 80 cm	60 × 60 cm	100 × 100 cm	80 × 80 cm	60 × 60 cm	80 × 40 cm		

